



ERNSTES DESIGN

JEWELRY MADE IN GERMANY



HAUPTKATALOG | 2024-2025



SHARVIN

14K GELBGOLD
SYNTH. DIAMANTEN
MADE IN GERMANY



ERNSTES DESIGN

JEWELRY MADE IN GERMANY



NEUHEITEN HERBST 2024

4-13



RINGE

14-30



KETTEN

31-40



EVIA SCHMUCKSETS

41-44



ANHÄNGER

45-60



OHRSCHMUCK

61-79



ARMSCHMUCK

80-92



SEILE, KETTEN

93-98



ARMSPANGENMASSE

93



ALLGEMEINE INFORMATIONEN

99

ENTWURF UND HERSTELLUNG
Andreas Ernst

ERNSTES DESIGN
Max-Born-Straße 12
48529 Nordhorn

ernstesdesign.de

matt/gekratzt/poliert,
Brill. TW/SI
0,02 ct.

B: ca. 11 mm,
Gr. 48-65

R750
179,00 €

matt/gekratzt/poliert,
teilweise Gelbgold
beschichtet,
Brill. TW/SI
0,02 ct.

B: ca. 11 mm,
Gr. 48-65

R751
199,00 €

matt/gekratzt/
poliert,
Brill. TW/SI
0,035 ct.

Ø ca. 19 mm,
Kettenöffnung 2,1 mm

AN1029
179,00 €

matt/gekratzt/
poliert, teilweise
Gelbgold
beschichtet,
Brill. TW/SI
0,035 ct.

Ø ca. 19 mm,
Kettenöffnung 2,1 mm

AN1030
199,00 €

matt/gekratzt/poliert,
2x Brill. TW/SI
0,02 ct.

Ø ca. 10,5 mm

E730
199,00 €

matt/gekratzt/poliert,
Gelbgold
beschichtet,
2x Brill. TW/SI
0,02 ct.

Ø ca. 10,5 mm

E731
219,00 €

gekratzt/poliert

B: ca. 2,5 mm,
Ringkopf Ø ca. 9 mm,
Gr. 48-65

R746
64,00 €

gekratzt/poliert,
teilweise Gelbgold
beschichtet

B: ca. 2,5 mm,
Ringkopf Ø ca. 9 mm,
Gr. 48-65

R747
73,00 €

gekratzt/poliert

Ø ca. 17 mm,
Kettenöffnung 2,1 mm

AN1017
49,00 €

gekratzt/geschliffen,
teilweise Gelbgold
beschichtet

Ø ca. 17 mm,
Kettenöffnung 2,1 mm

AN1018
62,00 €

gekratzt/poliert

Ø ca. 39 mm,
Kettenöffnung 3,6 mm

AN1019
75,00 €

gekratzt/geschliffen,
teilweise Gelbgold
beschichtet

Ø ca. 39 mm,
Kettenöffnung 3,6 mm

AN1020
99,00 €

gekratzt/poliert

Ø ca. 9 mm

E724
59,00 €

gekratzt/poliert,
teilweise Gelbgold
beschichtet

Ø ca. 9 mm

E725
69,00 €

matt/poliert/
gekratzt

Ø ca. 20 mm,
Kettenöffnung 3 mm

AN1025
75,00 €

matt/poliert/
gekratzt, teilweise
Gelbgold
beschichtet

Ø ca. 20 mm,
Kettenöffnung 3 mm

AN1026
85,00 €

matt/poliert/
gekratzt

Ø ca. 40 mm,
Kettenöffnung 3,5 mm

AN1027
99,00 €

matt/poliert/
gekratzt,
teilweise
Gelbgold
beschichtet

Ø ca. 40 mm,
Kettenöffnung 3,5 mm

AN1028
119,00 €

matt/poliert/gekratzt

Ø ca. 20 mm

E728
119,00 €

matt/poliert/gekratzt,
teilweise Gelbgold
beschichtet

Ø ca. 9 mm

E729
135,00 €

poliert,
Zirkonia white

ca. 6x10 mm,
Kettenöffnung 3,6 mm

AN1031
39,00 €

poliert, Gelbgold
beschichtet,
Zirkonia white

ca. 6x10 mm,
Kettenöffnung 3,6 mm

AN1032
49,00 €

matt/polirt,
SW-Perle
Ø ca. 6 mm



B: ca. 5 mm,
Gr. 48-65

R748
99,00 €

matt/polirt,
Gelbgold
beschichtet,
SW-Perle
Ø ca. 6 mm



B: ca. 5 mm,
Gr. 48-65

R749
129,00 €

matt/polirt,
SW-Perle
Ø ca. 5 mm



Ø ca. 13,5 mm,
Kettenöffnung 2,2 mm

AN1021
69,00 €

matt/polirt,
Gelbgold
beschichtet,
SW-Perle
Ø ca. 5 mm



Ø ca. 13,5 mm,
Kettenöffnung 2,2 mm

AN1022
85,00 €

matt/polirt,
SW-Perle
Ø ca. 6 mm



Ø ca. 20 mm,
Kettenöffnung 3,7 mm

AN1023
79,00 €

matt/polirt,
Gelbgold
beschichtet,
SW-Perle
Ø ca. 6 mm



Ø ca. 20 mm,
Kettenöffnung 3,7 mm

AN1024
99,00 €

matt/polirt, SW-Perlen
Ø ca. 5 mm



Ø ca. 13,5 mm

E726
99,00 €

matt/polirt, Gelbgold
beschichtet, SW-Perlen
Ø ca. 5 mm



Ø ca. 13,5 mm

E727
129,00 €

matt/polirt,
facettierter Granat



B: ca. 2,5 mm,
Gr. 48-65

R742
69,00 €

matt/polirt,
teilweise Gelbgold
beschichtet,
facettierter Granat



B: ca. 2,5 mm,
Gr. 48-65

R743
89,00 €

matt/polirt,
facettierter Granat



B: ca. 2,5 mm,
Ringkopf Ø ca. 12 mm,
Gr. 48-65

R744
89,00 €

matt/polirt,
facettierter Granat



B: ca. 2,5 mm,
Ringkopf Ø ca. 12 mm,
Gr. 48-65

R745
113,00 €

matt/polirt,
facettierter Granat,
Spiegelankerkette Ø 1,5 mm



Ø ca. 12/19 mm,
L: ca. 42, 45, 50 cm,
mit Clic-Verschluss Ø 2 mm

K843
115,00 €

matt/polirt, teilweise
Gelbgold beschichtet,
facettierter Granat,
Spiegelankerkette Ø 1,5 mm



Ø ca. 12/19 mm,
L: ca. 42, 45, 50 cm,
mit Clic-Verschluss Ø 2 mm

K844
135,00 €

matt/polirt,
Gelbgold beschichtet,
facettierter Granat,
Spiegelankerkette Ø 1,5 mm



Ø ca. 12/19 mm,
L: ca. 42, 45, 50 cm,
mit Clic-Verschluss Ø 2 mm

K845
145,00 €



matt/poliert,
facettierter
Hämatit,
Spiegelankerkette
Ø 1,5 mm



L: variabel verstellbar
(max. 78 cm),
Hämatit: L. ca. 3,5 cm
ohne Verschluss

K846
59,00 €

matt/poliert,
Gelbgold
beschichtet,
facettierter
Hämatit,
Spiegelankerkette
Ø 1,5 mm



L: variabel verstellbar
(max. 78 cm),
Hämatit: L. ca. 3,5 cm
ohne Verschluss

K847
95,00 €

matt/poliert,
facettierter
Granat,
Spiegelankerkette
Ø 1,5 mm



L: variabel verstellbar
(max. 78 cm),
Granat: L. ca. 3,5 cm
ohne Verschluss

K848
59,00 €

matt/poliert,
Gelbgold
beschichtet,
facettierter
Granat,
Spiegelankerkette
Ø 1,5 mm



L: variabel verstellbar
(max. 78 cm),
Granat: L. ca. 3,5 cm
ohne Verschluss

K849
95,00 €

matt, facettierter Hämatit
Ø ca. 2,5 mm



Preis bis 50 cm Länge,
mit Clic-Verschluss Ø 2 mm

K850
89,00 €

matt, teilweise
Gelbgold
beschichtet,
facettierter Hämatit
Ø ca. 2,5 mm



Preis bis 50 cm Länge,
mit Clic-Verschluss Ø 2 mm

K851
99,00 €

matt, facettierter Granat
Ø ca. 2,5 mm



Preis bis 50 cm Länge,
mit Clic-Verschluss Ø 2 mm

K852
89,00 €

matt, teilweise
Gelbgold
beschichtet,
facettierter Granat
Ø ca. 2,5 mm



Preis bis 50 cm Länge,
mit Clic-Verschluss Ø 2 mm

K853
99,00 €

matt, facettierter Peridot
Ø ca. 2,5 mm



Preis bis 50 cm Länge,
mit Clic-Verschluss Ø 2 mm

K854
89,00 €

matt, teilweise
Gelbgold
beschichtet,
facettierter Peridot
Ø ca. 2,5 mm



Preis bis 50 cm Länge,
mit Clic-Verschluss Ø 2 mm

K855
99,00 €

matt/poliert,
facettierter
Granat



Ø ca. 19 mm,
Kettenöffnung 2,9 mm

AN1009
64,00 €

matt/poliert,
Gelbgold
beschichtet,
facettierter
Granat



Ø ca. 19 mm,
Kettenöffnung 2,9 mm

AN1010
79,00 €

matt/poliert,
facettierter
Granat



Ø ca. 30 mm,
Kettenöffnung 2,9 mm

AN1011
69,00 €

matt/poliert,
Gelbgold
beschichtet,
facettierter
Granat



Ø ca. 30 mm,
Kettenöffnung 2,9 mm

AN1012
89,00 €

matt/poliert,
facettierter
Hämatit,
Spiegelankerkette
Ø 1,5 mm



L: ca. 7,4 cm
(Hämatit ca. 3 cm),
Kettenöffnung
ca. 3,8 mm

AN1013
53,00 €

matt/poliert,
Gelbgold
beschichtet,
facettierter
Hämatit,
Spiegelankerkette
Ø 1,5 mm



L: ca. 7,4 cm
(Hämatit ca. 3 cm),
Kettenöffnung
ca. 3,8 mm

AN1014
63,00 €

matt/poliert,
facettierter
Granat,
Spiegelankerkette
Ø 1,5 mm



L: ca. 7,4 cm
(Granat ca. 3 cm),
Kettenöffnung
ca. 3,8 mm

AN1015
53,00 €

matt/poliert,
Gelbgold
beschichtet,
facettierter
Granat,
Spiegelankerkette
Ø 1,5 mm



L: ca. 7,4 cm
(Granat ca. 3 cm),
Kettenöffnung
ca. 3,8 mm

AN1016
63,00 €

matt/poliert,
facettierter
Granat



Ø ca. 14 mm

E695
89,00 €

matt/poliert,
Gelbgold
beschichtet,
facettierter
Granat



Ø ca. 14 mm

E696
105,00 €

matt/poliert,
facettierter
Granat



Ø ca. 12/19 mm,
L: ca. 34 mm

E697
129,00 €

matt/poliert,
Gelbgold
beschichtet,
facettierter
Granat



Ø ca. 12/19 mm,
L: ca. 34 mm

E698
159,00 €

matt/poliert,
facettierter
Granat



Ø ca. 30 mm

E699
119,00 €

matt/poliert,
Gelbgold
beschichtet,
facettierter
Granat



Ø ca. 30 mm

E700
149,00 €

matt/poliert,
facettierter
Hämatit,
Spiegelankerkette
Ø 1,5 mm



L: ca. 7,8 cm
(Hämatit ca. 3 cm),
Ohrsteckerkopf:
Ø ca. 6 mm

E701
79,00 €

matt/poliert,
Gelbgold
beschichtet,
facettierter
Hämatit,
Spiegelankerkette
Ø 1,5 mm



L: ca. 7,8 cm
(Hämatit ca. 3 cm),
Ohrsteckerkopf:
Ø ca. 6 mm

E702
99,00 €

matt/poliert,
facettierter
Granat,
Spiegelankerkette
Ø 1,5 mm



L: ca. 7,8 cm
(Granat ca. 3 cm),
Ohrsteckerkopf:
Ø ca. 6 mm

E703
79,00 €

matt/poliert,
Gelbgold
beschichtet,
facettierter
Granat,
Spiegelankerkette
Ø 1,5 mm



L: ca. 7,8 cm
(Granat ca. 3 cm),
Ohrsteckerkopf:
Ø ca. 6 mm

E704
99,00 €

matt/poliert, facettierter
Granat, Spiegelankerkette
Ø 1,5 mm



Ø ca. 12/19 mm,
L: ca. 16, 17, 18, 19, 20, 21 cm,
mit Clic-Verschluss Ø 2 mm

A626
109,00 €

matt/poliert, teilweise Gelbgold
beschichtet, facettierter Granat,
Spiegelankerkette
Ø 1,5 mm



Ø ca. 12/19 mm,
L: ca. 16, 17, 18, 19, 20, 21 cm,
mit Clic-Verschluss Ø 2 mm

A627
129,00 €

matt/poliert, Gelbgold beschichtet,
facettierter Granat,
Spiegelankerkette
Ø 1,5 mm



Ø ca. 12/19 mm,
L: ca. 16, 17, 18, 19, 20, 21 cm,
mit Clic-Verschluss Ø 2 mm

A628
145,00 €

matt, facettierter
Hämatit



L: ca. 16, 17, 18, 19, 20, 21 cm,
mit Clic-Verschluss Ø 2 mm

A629
69,00 €

matt, teilweise Gelbgold beschichtet,
facettierter Hämatit



L: ca. 16, 17, 18, 19, 20, 21 cm,
mit Clic-Verschluss Ø 2 mm

A630
79,00 €

matt, facettierter
Granat



L: ca. 16, 17, 18, 19, 20, 21 cm,
mit Clic-Verschluss Ø 2 mm

A631
69,00 €

matt, teilweise Gelbgold beschichtet,
facettierter Granat



L: ca. 16, 17, 18, 19, 20, 21 cm,
mit Clic-Verschluss Ø 2 mm

A632
79,00 €

matt, facettierter
Peridot



L: ca. 16, 17, 18, 19, 20, 21 cm,
mit Clic-Verschluss Ø 2 mm

A633
69,00 €

matt, teilweise Gelbgold beschichtet,
facettierter Peridot



L: ca. 16, 17, 18, 19, 20, 21 cm,
mit Clic-Verschluss Ø 2 mm

A634
79,00 €

matt,
facettierter Hämatit,
Spiegelankerkette Ø 1,5 mm



L: ca. 16, 17, 18, 19, 20, 21 cm,
mit Clic-Verschluss Ø 2 mm

A635
89,00 €

matt, Gelbgold beschichtet,
facettierter Hämatit,
Spiegelankerkette Ø 1,5 mm



L: ca. 16, 17, 18, 19, 20, 21 cm,
mit Clic-Verschluss Ø 2 mm

A636
105,00 €

matt,
facettierter Granat,
Spiegelankerkette Ø 1,5 mm



L: ca. 16, 17, 18, 19, 20, 21 cm,
mit Clic-Verschluss Ø 2 mm

























A637
89,00 €

matt, Gelbgold beschichtet,
facettierter Granat,
Spiegelankerkette Ø 1,5 mm



L: ca. 16, 17, 18, 19, 20, 21 cm,
mit Clic-Verschluss Ø 2 mm

A638
105,00 €

<p>matt/polier</p>  <p><i>edia</i></p> <p>B: ca. 3,5 mm, Gr. 48-65</p> <p>R760 33,00 €</p>	<p>matt/polier, Gelbgold beschichtet</p>  <p><i>edia</i></p> <p>B: ca. 3,5 mm, Gr. 48-65</p> <p>R761 53,00 €</p>	<p>matt/polier</p>  <p><i>edia</i></p> <p>B: ca. 6 mm, Gr. 48-65</p> <p>R762 36,00 €</p>	<p>matt/polier, Gelbgold beschichtet</p>  <p><i>edia</i></p> <p>B: ca. 6 mm, Gr. 48-65</p> <p>R763 56,00 €</p>
<p>matt/polier</p>  <p><i>edia</i></p> <p>B: ca. 8 mm, Gr. 48-65</p> <p>R764 39,00 €</p>	<p>matt/polier, Gelbgold beschichtet</p>  <p><i>edia</i></p> <p>B: ca. 8 mm, Gr. 48-65</p> <p>R765 59,00 €</p>	<p>matt/polier, Zirkonia white</p>  <p><i>edia</i></p> <p>B: ca. 3,5 mm, Gr. 48-65</p> <p>R766 75,00 €</p>	<p>matt/polier, Gelbgold beschichtet, Zirkonia white</p>  <p><i>edia</i></p> <p>B: ca. 3,5 mm, Gr. 48-65</p> <p>R767 95,00 €</p>
<p>matt/polier, Zirkonia white</p>  <p><i>edia</i></p> <p>B: ca. 6 mm, Gr. 48-65</p> <p>R768 77,00 €</p>	<p>matt/polier, Gelbgold beschichtet, Zirkonia white</p>  <p><i>edia</i></p> <p>B: ca. 6 mm, Gr. 48-65</p> <p>R769 97,00 €</p>	<p>matt/polier, Zirkonia white</p>  <p><i>edia</i></p> <p>B: ca. 8 mm, Gr. 48-65</p> <p>R770 79,00 €</p>	<p>matt/polier, Gelbgold beschichtet, Zirkonia white</p>  <p><i>edia</i></p> <p>B: ca. 8 mm, Gr. 48-65</p> <p>R771 99,00 €</p>
<p>matt/polier</p>  <p><i>edia</i></p> <p>ca. 3,5x25 mm, Kettenöffnung ca. 2,5 mm</p> <p>AN1035 32,00 €</p>	<p>matt/polier, Gelbgold beschichtet</p>  <p><i>edia</i></p> <p>ca. 3,5x25 mm, Kettenöffnung ca. 2,5 mm</p> <p>AN1036 45,00 €</p>	<p>matt/polier, Zirkonia white</p>  <p><i>edia</i></p> <p>ca. 3,5x25 mm, Kettenöffnung ca. 2,5 mm</p> <p>AN1037 45,00 €</p>	<p>matt/polier, Gelbgold beschichtet, Zirkonia white</p>  <p><i>edia</i></p> <p>ca. 3,5x25 mm, Kettenöffnung ca. 2,5 mm</p> <p>AN1038 59,00 €</p>
<p>matt/polier</p>  <p><i>edia</i></p> <p>ca. 3,5x14,5 mm</p> <p>E705 29,00 €</p>	<p>matt/polier, Gelbgold beschichtet</p>  <p><i>edia</i></p> <p>ca. 3,5x14,5 mm</p> <p>E706 45,00 €</p>	<p>matt/polier</p>  <p><i>edia</i></p> <p>ca. 6x14,5 mm</p> <p>E707 32,00 €</p>	<p>matt/polier, Gelbgold beschichtet</p>  <p><i>edia</i></p> <p>ca. 6x14,5 mm</p> <p>E708 48,00 €</p>
<p>matt/polier, Zirkonia white</p>  <p><i>edia</i></p> <p>ca. 3,5x14,5 mm</p> <p>E709 45,00 €</p>	<p>matt/polier, Gelbgold beschichtet, Zirkonia white</p>  <p><i>edia</i></p> <p>ca. 3,5x14,5 mm</p> <p>E710 59,00 €</p>	<p>matt/polier, Zirkonia white</p>  <p><i>edia</i></p> <p>ca. 6x14,5 mm</p> <p>E711 49,00 €</p>	<p>matt/polier, Gelbgold beschichtet, Zirkonia white</p>  <p><i>edia</i></p> <p>ca. 6x14,5 mm</p> <p>E712 64,00 €</p>

matt/polier



edia

B: ca. 3,5 mm,
Ø ca. 16 mm

E713
59,00 €

matt/polier,
Gelbgold
beschichtet



edia

B: ca. 3,5 mm,
Ø ca. 16 mm

E714
45,00 €

matt/polier



edia

B: ca. 3,5 mm,
Ø ca. 40 mm

E715
75,00 €

matt/polier,
Gelbgold
beschichtet



edia

B: ca. 3,5 mm,
Ø ca. 40 mm

E716
99,00 €

matt/polier,
Zirkonia white



edia

B: ca. 3,5 mm,
Ø ca. 16 mm

E717
79,00 €

matt/polier,
Gelbgold
beschichtet,
Zirkonia white



edia

B: ca. 3,5 mm,
Ø ca. 16 mm

E718
99,00 €

matt/polier,
Zirkonia white



edia

B: ca. 3,5 mm,
Ø ca. 40 mm

E719
109,00 €

matt/polier,
Gelbgold
beschichtet,
Zirkonia white



edia

B: ca. 3,5 mm,
Ø ca. 40 mm

E720
135,00 €

matt/polier,
Zirkonia white



edia

B: ca. 2 mm,
Ø ca. 14 mm

E721
88,00 €

matt/polier,
Gelbgold
beschichtet,
Zirkonia white



edia

B: ca. 2 mm,
Ø ca. 14 mm

E722
111,00 €

matt/polier,
Roségold
beschichtet,
Zirkonia white



edia

B: ca. 2 mm,
Ø ca. 14 mm

E723
111,00 €



matt/poliert



evia

B: ca. 4 mm,
Gr. S, M, L

A639
65,00 €

matt/poliert,
Gelbgold
beschichtet



evia

B: ca. 4 mm,
Gr. S, M, L

A640
89,00 €

matt/poliert



evia

B: ca. 6 mm,
Gr. S, M, L

A643
89,00 €

matt/poliert,
Gelbgold
beschichtet



evia

B: ca. 6 mm,
Gr. S, M, L

A644
115,00 €

matt/poliert,
Zirkonia white



evia

B: ca. 4 mm,
Gr. S, M, L

A641
89,00 €

matt/poliert,
Gelbgold
beschichtet,
Zirkonia white



evia

B: ca. 4 mm,
Gr. S, M, L

A642
115,00 €

matt/poliert,
Zirkonia white



evia

B: ca. 6 mm,
Gr. S, M, L

A645
95,00 €

matt/poliert,
Gelbgold
beschichtet,
Zirkonia white



evia

B: ca. 6 mm,
Gr. S, M, L

A646
119,00 €



matt/poliert



ED **vita** petit

B: ca. 14 mm,
WechselschlieÙe klein
für Magnetverschluss
ohne Gewinde

AN759
43,00 €

matt/poliert,
teilweise Gelbgold
beschichtet



ED **vita** petit

B: ca. 14 mm,
WechselschlieÙe klein
für Magnetverschluss
ohne Gewinde

AN760
55,00 €

poliert



ED **vita** petit

Magnet-Carrier,
Kettenöffnung
ca. 2,5 mm

AN1040
19,00 €

poliert



ED **vita** petit

L: ca. 5 cm+Magnet,
für Magnetverschluss
ohne Gewinde

AN1041
45,00 €

poliert, teilweise
Gelbgold
beschichtet



ED **vita** petit

L: ca. 5 cm+Magnet,
für Magnetverschluss
ohne Gewinde

AN1042
49,00 €

poliert,
facettierter Hämatit



ED **vita** petit

L: ca. 5 cm+Magnet,
für Magnetverschluss
ohne Gewinde

AN1043
49,00 €

poliert, facettierter
Hämatit, teilweise
Gelbgold
beschichtet



ED **vita** petit

L: ca. 5 cm+Magnet,
für Magnetverschluss
ohne Gewinde

AN1044
55,00 €

poliert,
facettierter Granat



ED **vita** petit

L: ca. 5 cm+Magnet,
für Magnetverschluss
ohne Gewinde

AN1045
49,00 €

poliert, facettierter
Granat, teilweise
Gelbgold
beschichtet



ED **vita** petit

L: ca. 5 cm+Magnet,
für Magnetverschluss
ohne Gewinde

AN1046
55,00 €

poliert,
facettierter Peridot



ED **vita** petit

L: ca. 5 cm+Magnet,
für Magnetverschluss
ohne Gewinde

AN1047
49,00 €

poliert, facettierter
Peridot, teilweise
Gelbgold
beschichtet



ED **vita** petit

L: ca. 5 cm+Magnet,
für Magnetverschluss
ohne Gewinde

AN1048
55,00 €

matt/poliert,
(AK45C+AN759+
AN1040+AN1041)



ED **vita** petit

L: 42/45/50 cm,
mit Clic-Verschluss
Ø 2 mm und
Magnetverschluss klein
ohne Gewinde

K203
186,00 €

matt/poliert,
teilweise Gelbgold
beschichtet
(AK45C+AN759+
AN1040+AN1041)



ED **vita** petit

L: 42/45/50 cm,
mit Clic-Verschluss
Ø 2 mm und
Magnetverschluss klein
ohne Gewinde

K204
222,00 €

AK45C 79,00 €

AK46C 99,00 €

Ankerkette, 3-fach,
Ø 3x 1,5 mm, poliert,
teilweise Gelbgold
beschichtet,
Preise bis 60 cm Länge,
mit Clic-Verschluss Ø 2,5 mm





































NEUES KOMBINATIONSSYSTEM

ENTDECKEN SIE DIE PASSENDEN WECHSELSCHLIESSEN AUF SEITE 58-60!















ED **vita** petit



<p>matt, Platin 960/ Titan</p>  <p>R91 B: 4 mm, Gr. 48-71 562,00 €</p>	<p>matt, Platin 960/Titan, Brill. TW/SI 0,035 ct.</p>  <p>R92 B: 4 mm, Gr. 48-71 758,00 €</p>	<p>matt, Platin 960/Titan</p>  <p>R85 B: 6 mm, Gr. 48-71 580,00 €</p>	<p>matt, Platin 960/Titan, Brill. TW/SI 0,035 ct.</p>  <p>R86 B: 6 mm, Gr. 48-71 776,50 €</p>
<p>matt, Platin 960/Titan</p>  <p>R111 B: 4 mm, Gr. 48-71 462,00 €</p>	<p>matt, Platin 960/Titan, TW/SI 0,012 ct.</p>  <p>R112 B: 4 mm, Gr. 48-71 537,00 €</p>	<p>matt, Platin 960/Titan</p>  <p>R87 B: 6 mm, Gr. 48-71 813,00 €</p>	<p>matt, Platin 960/Titan, Brill. TW/SI 0,035 ct.</p>  <p>R88 B: 6 mm, Gr. 48-71 1.008,00 €</p>
<p>matt, Platin 960/Titan</p>  <p>R93 B: 7 mm, Gr. 48-71 601,00 €</p>	<p>matt, Platin 960/Titan, Dia. Princess Cut TW/SI 0,05 ct.</p>  <p>R94 B: 7 mm, Gr. 48-71 884,00 €</p>	<p>matt, 585er Gelbgold</p>  <p>R76 B: 7 mm, Gr. 48-71 218,00 €</p>	<p>matt, 585er Gelbgold, Dia. Princess Cut TW/SI 0,05 ct.</p>  <p>R77 B: 7 mm, Gr. 48-71 463,00 €</p>
<p>matt, 585er Gelbgold</p>  <p>R57 B: 4 mm, Gr. 48-71 195,00 €</p>	<p>matt, 585er Gelbgold, Brill. TW/SI 0,035 ct.</p>  <p>R58 B: 4 mm, Gr. 48-71 364,00 €</p>	<p>matt, 585er Gelbgold</p>  <p>R51 B: 6 mm, Gr. 48-71 199,00 €</p>	<p>matt, 585er Gelbgold, Brill. TW/SI 0,035 ct.</p>  <p>R52 B: 6 mm, Gr. 48-71 372,00 €</p>
<p>matt, 585er Gelbgold</p>  <p>R109 B: 4 mm, Gr. 48-71 199,00 €</p>	<p>matt, 585er Gelbgold, Brill. TW/SI 0,012 ct.</p>  <p>R110 B: 4 mm, Gr. 48-71 268,00 €</p>	<p>matt, 585er Gelbgold</p>  <p>R53 B: 6 mm, Gr. 48-71 289,00 €</p>	<p>matt, 585er Gelbgold, Brill. TW/SI 0,035 ct.</p>  <p>R54 B: 6 mm, Gr. 48-71 458,00 €</p>
<p>matt, 585er Gelbgold</p>  <p>R98 B: 6 mm, Gr. 48-71 209,00 €</p>	<p>matt, 585er Gelbgold, Brill. TW/SI 0,02 ct.</p>  <p>R99 B: 6 mm, Gr. 48-71 299,00 €</p>	<p>matt/poliert, 585er Gelbgold</p>  <p>R180 B: 8 mm, Gr. 48-71 213,00 €</p>	<p>matt/poliert, 585er Gelbgold, Brill. TW/SI 0,02 ct.</p>  <p>R181 B: 8 mm, Gr. 48-71 299,00 €</p>

<p>matt/polirt, 585er Gelbgold</p>  <p>R176 199,00 €</p> <p>B: 6 mm, Gr. 48-71</p>	<p>matt/polirt, 585er Gelbgold, Brill. TW/SI 0,02 ct.</p>  <p>R177 289,00 €</p> <p>B: 6 mm, Gr. 48-71</p>	<p>matt/polirt, 585er Gelbgold</p>  <p>R207 199,00 €</p> <p>B: 6 mm, Gr. 48-71</p>	<p>matt/polirt, 585er Gelbgold, Brill. TW/SI 0,035 ct.</p>  <p>R208 372,00 €</p> <p>B: 6 mm, Gr. 48-71</p>
<p>matt/polirt, 585er Gelbgold</p>  <p>R209 289,00 €</p> <p>B: 6 mm, Gr. 48-71</p>	<p>matt/polirt, 585er Gelbgold, Brill. TW/SI 0,035 ct.</p>  <p>R210 458,00 €</p> <p>B: 6 mm, Gr. 48-71</p>	<p>matt, 585er Gelbgold</p>  <p>R217.7 218,00 €</p> <p>B: 7 mm, Gr. 48-71</p>	<p>matt, 585er Gelbgold, Brill. TW/SI 0,035 ct.</p>  <p>R218.7 387,00 €</p> <p>B: 7 mm, Gr. 48-71</p>
<p>matt, 585er Gelbgold</p>  <p>R217.9 221,00 €</p> <p>B: 9 mm, Gr. 48-71</p>	<p>matt, 585er Gelbgold, Brill. TW/SI 0,035 ct.</p>  <p>R218.9 390,00 €</p> <p>B: 9 mm, Gr. 48-71</p>	<p>geschliffen/matt, 585er Gelbgold</p>  <p>R223.7 224,00 €</p> <p>B: 7 mm, Gr. 48-71</p>	<p>geschliffen/matt, 585er Gelbgold, Brill. TW/SI 0,035 ct.</p>  <p>R224.7 393,00 €</p> <p>B: 7 mm, Gr. 48-71</p>
<p>geschliffen/matt, 585er Gelbgold</p>  <p>R223.9 226,00 €</p> <p>B: 9 mm, Gr. 48-71</p>	<p>geschliffen/matt, 585er Gelbgold, Brill. TW/SI 0,035 ct.</p>  <p>R224.9 395,00 €</p> <p>B: 9 mm, Gr. 48-71</p>	<p>matt, 585er Gelbgold</p>  <p>R229.7 299,00 €</p> <p>B: 7 mm, Gr. 48-71</p>	<p>matt, 585er Gelbgold, Brill. TW/SI 0,035 ct.</p>  <p>R230.7 473,00 €</p> <p>B: 7 mm, Gr. 48-71</p>
<p>matt, 585er Gelbgold</p>  <p>R229.9 307,00 €</p> <p>B: 9 mm, Gr. 48-71</p>	<p>matt, 585er Gelbgold, Brill. TW/SI 0,035 ct.</p>  <p>R230.9 476,00 €</p> <p>B: 9 mm, Gr. 48-71</p>	<p>geschliffen/matt, 585er Gelbgold</p>  <p>R235.7 309,00 €</p> <p>B: 7 mm, Gr. 48-71</p>	<p>geschliffen/matt, 585er Gelbgold, Brill. TW/SI 0,035 ct.</p>  <p>R236.7 478,00 €</p> <p>B: 7 mm, Gr. 48-71</p>
<p>geschliffen/matt, 585er Gelbgold</p>  <p>R235.9 312,00 €</p> <p>B: 9 mm, Gr. 48-71</p>	<p>geschliffen/matt, 585er Gelbgold, Brill. TW/SI 0,035 ct.</p>  <p>R236.9 481,00 €</p> <p>B: 9 mm, Gr. 48-71</p>	<p>matt/polirt, 585er Roségold</p>  <p>R167 199,00 €</p> <p>B: 6 mm, Gr. 48-71</p>	<p>matt/polirt, 585er Roségold, Brill. TW/SI 0,035 ct.</p>  <p>R168 372,00 €</p> <p>B: 6 mm, Gr. 48-71</p>

<p>matt/poliert, 585er Roségold</p>  <p>R169 289,00 €</p> <p>B: 6 mm, Gr. 48-71</p>	<p>matt/poliert, 585er Roségold, Brill. TW/SI 0,035 ct.</p>  <p>R170 458,00 €</p> <p>B: 6 mm, Gr. 48-71</p>	<p>matt, 585er Roségold</p>  <p>R174 209,00 €</p> <p>B: 6 mm, Gr. 48-71</p>	<p>matt, 585er Roségold, Brill. TW/SI 0,02 ct.</p>  <p>R175 299,00 €</p> <p>B: 6 mm, Gr. 48-71</p>
<p>matt/poliert, 585er Roségold</p>  <p>R182 213,00 €</p> <p>B: 8 mm, Gr. 48-71</p>	<p>matt/poliert, 585er Roségold, Brill. TW/SI 0,02 ct.</p>  <p>R183 299,00 €</p> <p>B: 8 mm, Gr. 48-71</p>	<p>matt/poliert, 585er Roségold</p>  <p>R178 199,00 €</p> <p>B: 6 mm, Gr. 48-71</p>	<p>matt/poliert, 585er Roségold, Brill. TW/SI 0,02 ct.</p>  <p>R179 289,00 €</p> <p>B: 6 mm, Gr. 48-71</p>
<p>matt, 585er Roségold</p>  <p>R219.7 218,00 €</p> <p>B: 7 mm, Gr. 48-71</p>	<p>matt, 585er Roségold, Brill. TW/SI 0,035 ct.</p>  <p>R220.7 387,00 €</p> <p>B: 7 mm, Gr. 48-71</p>	<p>matt, 585er Roségold</p>  <p>R219.9 221,00 €</p> <p>B: 9 mm, Gr. 48-71</p>	<p>matt, 585er Roségold, Brill. TW/SI 0,035 ct.</p>  <p>R220.9 390,00 €</p> <p>B: 9 mm, Gr. 48-71</p>
<p>geschliffen/matt, 585er Roségold</p>  <p>R225.7 224,00 €</p> <p>B: 7 mm, Gr. 48-71</p>	<p>geschliffen/matt, 585er Roségold, Brill. TW/SI 0,035 ct.</p>  <p>R226.7 393,00 €</p> <p>B: 7 mm, Gr. 48-71</p>	<p>geschliffen/matt, 585er Roségold</p>  <p>R225.9 226,00 €</p> <p>B: 9 mm, Gr. 48-71</p>	<p>geschliffen/matt, 585er Roségold, Brill. TW/SI 0,035 ct.</p>  <p>R226.9 395,00 €</p> <p>B: 9 mm, Gr. 48-71</p>
<p>matt, 585er Roségold</p>  <p>R231.7 299,00 €</p> <p>B: 7 mm, Gr. 48-71</p>	<p>matt, 585er Roségold, Brill. TW/SI 0,035 ct.</p>  <p>R232.7 473,00 €</p> <p>B: 7 mm, Gr. 48-71</p>	<p>matt, 585er Roségold</p>  <p>R231.9 307,00 €</p> <p>B: 9 mm, Gr. 48-71</p>	<p>matt, 585er Roségold, Brill. TW/SI 0,035 ct.</p>  <p>R232.9 476,00 €</p> <p>B: 9 mm, Gr. 48-71</p>
<p>geschliffen/matt, 585er Roségold</p>  <p>R237.7 309,00 €</p> <p>B: 7 mm, Gr. 48-71</p>	<p>geschliffen/matt, 585er Roségold, Brill. TW/SI 0,035 ct.</p>  <p>R238.7 478,00 €</p> <p>B: 7 mm, Gr. 48-71</p>	<p>geschliffen/matt, 585er Roségold</p>  <p>R237.9 312,00 €</p> <p>B: 9 mm, Gr. 48-71</p>	<p>geschliffen/matt, 585er Roségold, Brill. TW/SI 0,035 ct.</p>  <p>R238.9 481,00 €</p> <p>B: 9 mm, Gr. 48-71</p>

<p>matt/polier</p>  <p>R215.7 53,50 €</p> <p>B: 7 mm, Gr. 48-71</p>	<p>matt/polier, Brill. TW/SI 0,02 ct.</p>  <p>R216.7 157,50 €</p> <p>B: 7 mm, Gr. 48-71</p>	<p>matt/polier</p>  <p>R215.9 56,00 €</p> <p>B: 9 mm, Gr. 48-71</p>	<p>matt/polier, Brill. TW/SI 0,02 ct.</p>  <p>R216.9 160,00 €</p> <p>B: 9 mm, Gr. 48-71</p>
<p>matt/polier</p>  <p>R227.7 53,50 €</p> <p>B: 7 mm, Gr. 48-71</p>	<p>matt/polier, Brill. TW/SI 0,02 ct.</p>  <p>R228.7 157,50 €</p> <p>B: 7 mm, Gr. 48-71</p>	<p>matt/polier</p>  <p>R227.9 56,00 €</p> <p>B: 9 mm, Gr. 48-71</p>	<p>matt/polier, Brill. TW/SI 0,02 ct.</p>  <p>R228.9 160,00 €</p> <p>B: 9 mm, Gr. 48-71</p>
<p>geschliffen/polier</p>  <p>R221.7 59,00 €</p> <p>B: 7 mm, Gr. 48-71</p>	<p>geschliffen/polier, Brill. TW/SI 0,02 ct.</p>  <p>R222.7 164,00 €</p> <p>B: 7 mm, Gr. 48-71</p>	<p>geschliffen/polier</p>  <p>R221.9 63,00 €</p> <p>B: 9 mm, Gr. 48-71</p>	<p>geschliffen/polier, Brill. TW/SI 0,02 ct.</p>  <p>R222.9 166,50 €</p> <p>B: 9 mm, Gr. 48-71</p>
<p>geschliffen/polier</p>  <p>R233.7 59,00 €</p> <p>B: 7 mm, Gr. 48-71</p>	<p>geschliffen/polier, Brill. TW/SI 0,02 ct.</p>  <p>R234.7 164,00 €</p> <p>B: 7 mm, Gr. 48-71</p>	<p>geschliffen/polier</p>  <p>R233.9 63,00 €</p> <p>B: 9 mm, Gr. 48-71</p>	<p>geschliffen/polier, Brill. TW/SI 0,02 ct.</p>  <p>R234.9 166,50 €</p> <p>B: 9 mm, Gr. 48-71</p>
<p>matt</p>  <p>R64.4 30,50 €</p> <p>B: 4 mm, Gr. 48-71</p>	<p>matt, Brill. TW/SI 0,02 ct.</p>  <p>R65.4 138,00 €</p> <p>B: 4 mm, Gr. 48-71</p>	<p>matt</p>  <p>R64.6 35,00 €</p> <p>B: 6 mm, Gr. 48-71</p>	<p>matt, Brill. TW/SI 0,02 ct.</p>  <p>R65.6 140,50 €</p> <p>B: 6 mm, Gr. 48-71</p>
<p>matt</p>  <p>R64.8 38,00 €</p> <p>B: 8 mm, Gr. 48-71</p>	<p>matt, Brill. TW/SI 0,02 ct.</p>  <p>R65.8 144,50 €</p> <p>B: 8 mm, Gr. 48-71</p>	<p>matt</p>  <p>R66.4 39,50 €</p> <p>B: 4 mm, Gr. 48-71</p>	<p>matt, Brill. TW/SI 0,02 ct.</p>  <p>R67.4 144,50 €</p> <p>B: 4 mm, Gr. 48-71</p>

<p>matt</p>  <p>R66.6 44,00 €</p> <p>B: 6 mm, Gr. 48-71</p>	<p>matt, Brill. TW/SI 0,02 ct.</p>  <p>R67.6 147,00 €</p> <p>B: 6 mm, Gr. 48-71</p>	<p>matt</p>  <p>R66.8 45,00 €</p> <p>B: 8 mm, Gr. 48-71</p>	<p>matt, Brill. TW/SI 0,02 ct.</p>  <p>R67.8 150,00 €</p> <p>B: 8 mm, Gr. 48-71</p>
<p>matt/poliert</p>  <p>R133.4 43,50 €</p> <p>B: 4 mm, Gr. 48-71</p>	<p>matt/poliert, Brill. TW/SI 0,02 ct.</p>  <p>R134.4 148,50 €</p> <p>B: 4 mm, Gr. 48-71</p>	<p>matt/poliert</p>  <p>R133.6 46,50 €</p> <p>B: 6 mm, Gr. 48-71</p>	<p>matt/poliert, Brill. TW/SI 0,02 ct.</p>  <p>R134.6 151,00 €</p> <p>B: 6 mm, Gr. 48-71</p>
<p>matt/poliert</p>  <p>R135 49,00 €</p> <p>B: 7 mm, Gr. 48-71</p>	<p>matt/poliert, Brill. TW/SI 0,02 ct.</p>  <p>R136 157,50 €</p> <p>B: 7 mm, Gr. 48-71</p>	<p>matt/poliert</p>  <p>R137.4 43,50 €</p> <p>B: 4 mm, Gr. 48-71</p>	<p>matt/poliert, Brill. TW/SI 0,02 ct.</p>  <p>R138.4 148,50 €</p> <p>B: 4 mm, Gr. 48-71</p>
<p>matt/poliert</p>  <p>R137.6 46,50 €</p> <p>B: 6 mm, Gr. 48-71</p>	<p>matt/poliert, Brill. TW/SI 0,02 ct.</p>  <p>R138.6 151,00 €</p> <p>B: 6 mm, Gr. 48-71</p>	<p>matt/poliert</p>  <p>R137.8 49,00 €</p> <p>B: 8 mm, Gr. 48-71</p>	<p>matt/poliert, Brill. TW/SI 0,02 ct.</p>  <p>R138.8 157,50 €</p> <p>B: 8 mm, Gr. 48-71</p>
<p>matt/poliert</p>  <p>R139 49,00 €</p> <p>B: 6 mm, Gr. 48-71</p>	<p>matt/poliert, Brill. TW/SI 0,02 ct.</p>  <p>R140 157,50 €</p> <p>B: 6 mm, Gr. 48-71</p>	<p>matt/poliert</p>  <p>R141 49,00 €</p> <p>B: 6 mm, Gr. 48-71</p>	<p>matt/poliert, Brill. TW/SI 0,02 ct.</p>  <p>R142 157,50 €</p> <p>B: 6 mm, Gr. 48-71</p>
<p>matt</p>  <p>R143.5 43,50 €</p> <p>B: 5 mm, Gr. 48-71</p>	<p>matt, Brill. TW/SI 0,02 ct.</p>  <p>R144.5 148,50 €</p> <p>B: 5 mm, Gr. 48-71</p>	<p>matt</p>  <p>R143.7 46,50 €</p> <p>B: 7 mm, Gr. 48-71</p>	<p>matt, Brill. TW/SI 0,02 ct.</p>  <p>R144.7 151,00 €</p> <p>B: 7 mm, Gr. 48-71</p>

<p>matt/polier</p>  <p>R145.6 59,00 €</p> <p>B: 6 mm, Gr. 48-71</p>	<p>matt/polier, Brill. TW/SI 0,02 ct.</p>  <p>R146.6 164,00 €</p> <p>B: 6 mm, Gr. 48-71</p>	<p>matt/polier</p>  <p>R145.8 63,00 €</p> <p>B: 8 mm, Gr. 48-71</p>	<p>matt/polier, Brill. TW/SI 0,02 ct.</p>  <p>R146.8 166,50 €</p> <p>B: 8 mm, Gr. 48-71</p>
<p>geschliffen</p>  <p>R360.4 35,00 €</p> <p>B: 4 mm, Gr. 48-71</p>	<p>geschliffen, Brill. TW/SI 0,02 ct.</p>  <p>R361.4 140,50 €</p> <p>B: 4 mm, Gr. 48-71</p>	<p>geschliffen</p>  <p>R360.6 38,00 €</p> <p>B: 6 mm, Gr. 48-71</p>	<p>geschliffen, Brill. TW/SI 0,02 ct.</p>  <p>R361.6 144,50 €</p> <p>B: 6 mm, Gr. 48-71</p>
<p>geschliffen</p>  <p>R360.8 41,00 €</p> <p>B: 8 mm, Gr. 48-71</p>	<p>geschliffen, Brill. TW/SI 0,02 ct.</p>  <p>R361.8 147,00 €</p> <p>B: 8 mm, Gr. 48-71</p>	<p>geschliffen/polier</p>  <p>R366.6 44,00 €</p> <p>B: 6 mm, Gr. 48-71</p>	<p>geschliffen/polier, Brill. TW/SI 0,02 ct.</p>  <p>R367.6 147,00 €</p> <p>B: 6 mm, Gr. 48-71</p>
<p>poliert</p>  <p>R600 49,00 €</p> <p>B: ca. 3,5 mm, Gr. 48-71</p>	<p>poliert, Brill. TW/SI 0,035 ct.</p>  <p>R603 182,00 €</p> <p>B: ca. 3,5 mm, Gr. 48-71</p>	<p>poliert</p>  <p>R601 53,50 €</p> <p>B: ca. 5 mm, Gr. 48-71</p>	<p>poliert, Brill. TW/SI 0,035 ct.</p>  <p>R604 185,00 €</p> <p>B: ca. 5 mm, Gr. 48-71</p>
<p>poliert, Brill. TW/SI 0,065 ct.</p>  <p>R605 299,00 €</p> <p>B: ca. 5 mm, Gr. 48-71</p>	<p>poliert</p>  <p>R602 56,00 €</p> <p>B: ca. 6,5 mm, Gr. 48-71</p>	<p>poliert, Brill. TW/SI 0,035 ct.</p>  <p>R606 187,50 €</p> <p>B: ca. 6,5 mm, Gr. 48-71</p>	<p>poliert, Brill. TW/SI 0,065 ct.</p>  <p>R607 308,50 €</p> <p>B: ca. 6,5 mm, Gr. 48-71</p>
<p>geschliffen/polier</p>  <p>R610 49,00 €</p> <p>B: ca. 3,5 mm, Gr. 48-71</p>	<p>geschliffen/polier, Brill. TW/SI 0,035 ct.</p>  <p>R613 182,00 €</p> <p>B: ca. 3,5 mm, Gr. 48-71</p>	<p>geschliffen/polier</p>  <p>R611 53,50 €</p> <p>B: ca. 5 mm, Gr. 48-71</p>	<p>geschliffen/polier, Brill. TW/SI 0,035 ct.</p>  <p>R614 185,00 €</p> <p>B: ca. 5 mm, Gr. 48-71</p>

<p>geschliffen/poliert, Brill. TW/SI 0,065 ct.</p>  <p>B: ca. 5 mm, Gr. 48-71</p> <p>R615 299,00 €</p>	<p>geschliffen/poliert</p>  <p>B: ca. 6,5 mm, Gr. 48-71</p> <p>R612 56,00 €</p>	<p>geschliffen/poliert, Brill. TW/SI 0,035 ct.</p>  <p>B: ca. 6,5 mm, Gr. 48-71</p> <p>R616 187,50 €</p>	<p>geschliffen/poliert, Brill. TW/SI 0,065 ct.</p>  <p>B: ca. 6,5 mm, Gr. 48-71</p> <p>R617 308,50 €</p>
<p>eismatt/poliert</p>  <p>B: ca. 3,5 mm, Gr. 48-71</p> <p>R620 49,00 €</p>	<p>eismatt/poliert, Brill. TW/SI 0,035 ct.</p>  <p>B: ca. 3,5 mm, Gr. 48-71</p> <p>R623 182,00 €</p>	<p>eismatt/poliert</p>  <p>B: ca. 5 mm, Gr. 48-71</p> <p>R621 53,50 €</p>	<p>eismatt/poliert, Brill. TW/SI 0,035 ct.</p>  <p>B: ca. 5 mm, Gr. 48-71</p> <p>R624 185,00 €</p>
<p>eismatt/poliert, Brill. TW/SI 0,065 ct.</p>  <p>B: ca. 5 mm, Gr. 48-71</p> <p>R625 299,00 €</p>	<p>eismatt/poliert</p>  <p>B: ca. 6,5 mm, Gr. 48-71</p> <p>R622 56,00 €</p>	<p>eismatt/poliert, Brill. TW/SI 0,035 ct.</p>  <p>B: ca. 6,5 mm, Gr. 48-71</p> <p>R626 187,50 €</p>	<p>eismatt/poliert, Brill. TW/SI 0,065 ct.</p>  <p>B: ca. 6,5 mm, Gr. 48-71</p> <p>R627 308,50 €</p>
<p>geschliffen/poliert</p>  <p>B: ca. 3,5 mm, Gr. 48-71</p> <p>R630 49,00 €</p>	<p>geschliffen/poliert, Brill. TW/SI 0,035 ct.</p>  <p>B: ca. 3,5 mm, Gr. 48-71</p> <p>R633 182,00 €</p>	<p>geschliffen/poliert</p>  <p>B: ca. 5 mm, Gr. 48-71</p> <p>R631 53,50 €</p>	<p>geschliffen/poliert, Brill. TW/SI 0,035 ct.</p>  <p>B: ca. 5 mm, Gr. 48-71</p> <p>R634 185,00 €</p>
<p>geschliffen/poliert, Brill. TW/SI 0,065 ct.</p>  <p>B: ca. 5 mm, Gr. 48-71</p> <p>R635 299,00 €</p>	<p>geschliffen/poliert</p>  <p>B: ca. 6,5 mm, Gr. 48-71</p> <p>R632 56,00 €</p>	<p>geschliffen/poliert, Brill. TW/SI 0,035 ct.</p>  <p>B: ca. 6,5 mm, Gr. 48-71</p> <p>R636 187,50 €</p>	<p>geschliffen/poliert, Brill. TW/SI 0,065 ct.</p>  <p>B: ca. 6,5 mm, Gr. 48-71</p> <p>R637 308,50 €</p>
<p>geschliffen/poliert</p>  <p>B: ca. 3,5 mm, Gr. 48-71</p> <p>R640 49,00 €</p>	<p>geschliffen/poliert, Brill. TW/SI 0,035 ct.</p>  <p>B: ca. 3,5 mm, Gr. 48-71</p> <p>R643 182,00 €</p>	<p>geschliffen/poliert</p>  <p>B: ca. 5 mm, Gr. 48-71</p> <p>R641 53,50 €</p>	<p>geschliffen/poliert, Brill. TW/SI 0,035 ct.</p>  <p>B: ca. 5 mm, Gr. 48-71</p> <p>R644 185,00 €</p>

<p>geschliffen/poliert, Brill. TW/SI 0,065 ct.</p>  <p>B: ca. 5 mm, Gr. 48-71</p> <p>R645 299,00 €</p>	<p>geschliffen/poliert</p>  <p>B: ca. 6,5 mm, Gr. 48-71</p> <p>R642 56,00 €</p>	<p>geschliffen/poliert, Brill. TW/SI 0,035 ct.</p>  <p>B: ca. 6,5 mm, Gr. 48-71</p> <p>R646 187,50 €</p>	<p>geschliffen/poliert, Brill. TW/SI 0,065 ct.</p>  <p>B: ca. 6,5 mm, Gr. 48-71</p> <p>R647 308,50 €</p>
<p>matt/facettiert/poliert</p>  <p>B: ca. 3,5 mm, Gr. 48-71</p> <p>R650 49,00 €</p>	<p>matt/facettiert/poliert, Brill. TW/SI 0,035 ct.</p>  <p>B: ca. 3,5 mm, Gr. 48-71</p> <p>R653 182,00 €</p>	<p>matt/facettiert/poliert</p>  <p>B: ca. 5 mm, Gr. 48-71</p> <p>R651 53,50 €</p>	<p>matt/facettiert/poliert, Brill. TW/SI 0,035 ct.</p>  <p>B: ca. 5 mm, Gr. 48-71</p> <p>R654 185,00 €</p>
<p>matt/facettiert/poliert, Brill. TW/SI 0,065 ct.</p>  <p>B: ca. 5 mm, Gr. 48-71</p> <p>R655 299,00 €</p>	<p>matt/facettiert/poliert</p>  <p>B: ca. 6,5 mm, Gr. 48-71</p> <p>R652 56,00 €</p>	<p>matt/facettiert/poliert, Brill. TW/SI 0,035 ct.</p>  <p>B: ca. 6,5 mm, Gr. 48-71</p> <p>R656 187,50 €</p>	<p>matt/facettiert/poliert, Brill. TW/SI 0,065 ct.</p>  <p>B: ca. 6,5 mm, Gr. 48-71</p> <p>R657 308,50 €</p>
<p>matt/graviert/poliert</p>  <p>B: ca. 3,5 mm, Gr. 48-71</p> <p>R660 49,00 €</p>	<p>matt/graviert/poliert, Brill. TW/SI 0,035 ct.</p>  <p>B: ca. 3,5 mm, Gr. 48-71</p> <p>R663 182,00 €</p>	<p>matt/graviert/poliert</p>  <p>B: ca. 5 mm, Gr. 48-71</p> <p>R661 53,50 €</p>	<p>matt/graviert/poliert, Brill. TW/SI 0,035 ct.</p>  <p>B: ca. 5 mm, Gr. 48-71</p> <p>R664 185,00 €</p>
<p>matt/graviert/poliert, Brill. TW/SI 0,065 ct.</p>  <p>B: ca. 5 mm, Gr. 48-71</p> <p>R665 299,00 €</p>	<p>matt/graviert/poliert</p>  <p>B: ca. 6,5 mm, Gr. 48-71</p> <p>R662 56,00 €</p>	<p>matt/graviert/poliert, Brill. TW/SI 0,035 ct.</p>  <p>B: ca. 6,5 mm, Gr. 48-71</p> <p>R666 187,50 €</p>	<p>matt/graviert/poliert, Brill. TW/SI 0,065 ct.</p>  <p>B: ca. 6,5 mm, Gr. 48-71</p> <p>R667 308,50 €</p>
<p>matt/graviert/poliert</p>  <p>B: ca. 3,5 mm, Gr. 48-71</p> <p>R670 49,00 €</p>	<p>matt/graviert/poliert, Brill. TW/SI 0,035 ct.</p>  <p>B: ca. 3,5 mm, Gr. 48-71</p> <p>R673 182,00 €</p>	<p>matt/graviert/poliert</p>  <p>B: ca. 5 mm, Gr. 48-71</p> <p>R671 53,50 €</p>	<p>matt/graviert/poliert, Brill. TW/SI 0,035 ct.</p>  <p>B: ca. 5 mm, Gr. 48-71</p> <p>R674 185,00 €</p>

matt/graviert/poliert,
Brill. TW/SI 0,065 ct.



B: ca. 5 mm,
Gr. 48-71

R675
299,00 €

matt/graviert/poliert



B: ca. 6,5 mm,
Gr. 48-71

R672
56,00 €

matt/graviert/poliert,
Brill. TW/SI 0,035 ct.



B: ca. 6,5 mm,
Gr. 48-71

R676
187,50 €

matt/graviert/poliert,
Brill. TW/SI 0,065 ct.



B: ca. 6,5 mm,
Gr. 48-71

R677
308,50 €

matt/poliert,
6x Brill. TW/SI,
insg. 0,07 ct.



B: ca. 6 mm,
Gr. 48-71

R678
408,50 €

matt/poliert,
7x Brill. TW/SI,
insg. 0,10 ct.

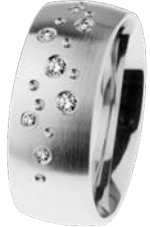

B: ca. 8 mm,
Gr. 48-71

R679
532,00 €

poliert,
Brill. TW/SI 0,016 ct.



B: 2 mm, Gr. 48-65

R352
104,00 €

poliert,
Brill. TW/SI 0,035 ct.



B: 2 mm, Gr. 48-65

R353
187,50 €

poliert,
Brill. TW/SI 0,065 ct.



B: 2 mm, Gr. 48-65

R354
299,00 €

matt/poliert,
Brill. TW/SI 0,10 ct.



B: ca. 3 mm,
Gr. 48-65

R717
465,00 €

matt/poliert,
Brill. TW/SI 0,15 ct.



B: ca. 3 mm,
Gr. 48-65

R718
675,00 €

matt/poliert,
Brill. TW/SI 0,25 ct.



B: ca. 3 mm,
Gr. 48-65

R719
1239,00 €

matt/poliert,
Brill. TW/SI 0,065 ct.



B: ca. 2,5 mm,
Gr. 48-65

R704
299,00 €

matt/poliert,
Brill. TW/SI 0,10 ct.



B: ca. 3 mm,
Gr. 48-65

R705
465,50 €

matt/poliert,
Brill. TW/SI 0,15 ct.



B: ca. 3,5 mm,
Gr. 48-65

R706
673,50 €

matt/poliert,
Brill. TW/SI 0,25 ct.



B: ca. 4 mm,
Gr. 48-65

R707
1.240,50 €

matt/poliert,
Brill. TW/SI 0,02 ct.



B: ca. 3 mm, Gr. 48-65

R504
139,50 €

poliert,
Brill. TW/SI 0,02 ct.



B: ca. 3 mm, Gr. 48-65

R505
139,50 €

matt/poliert,
Brill. TW/SI 0,035 ct.



B: ca. 3 mm, Gr. 48-65

R506
182,00 €

poliert,
Brill. TW/SI 0,035 ct.



B: ca. 3 mm, Gr. 48-65

R507
182,00 €

matt/poliert,
Brill. TW/SI 0,065 ct.



B: ca. 3 mm, Gr. 48-65

R508
294,00 €

poliert,
Brill. TW/SI 0,065 ct.



B: ca. 3 mm, Gr. 48-65

R509
294,00 €

matt/poliert,
Brill. TW/SI 0,02 ct.



B: ca. 5 mm, Gr. 48-65

























R510
146,00 €













poliert,
Brill. TW/SI 0,02 ct.





















B: ca. 5 mm, Gr. 48-65

R511
146,00 €

<p>matt/polirt, Brill. TW/SI 0,035 ct.</p>  <p>R512 B: ca. 5 mm, Gr. 48-65 185,00 €</p>	<p>polirt, Brill. TW/SI 0,035 ct.</p>  <p>R513 B: ca. 5 mm, Gr. 48-65 185,00 €</p>	<p>matt/polirt, Brill. TW/SI 0,065 ct.</p>  <p>R514 B: ca. 5 mm, Gr. 48-65 299,00 €</p>	<p>polirt, Brill. TW/SI 0,065 ct.</p>  <p>R515 B: ca. 5 mm, Gr. 48-65 299,00 €</p>
<p>matt/polirt, Brill. TW/SI 0,10 ct.</p>  <p>R516 B: ca. 5 mm, Gr. 48-65 465,50 €</p>	<p>polirt, Brill. TW/SI 0,10 ct.</p>  <p>R517 B: ca. 5 mm, Gr. 48-65 465,50 €</p>	<p>matt/polirt, Brill. TW/SI 0,15 ct.</p>  <p>R518 B: ca. 5 mm, Gr. 48-65 673,50 €</p>	<p>polirt, Brill. TW/SI 0,15 ct.</p>  <p>R519 B: ca. 5 mm, Gr. 48-65 673,50 €</p>
<p>matt/polirt, Brill. TW/SI 0,25 ct.</p>  <p>R520 B: ca. 5 mm, Gr. 48-65 1.240,50 €</p>	<p>polirt, Brill. TW/SI 0,25 ct.</p>  <p>R521 B: ca. 5 mm, Gr. 48-65 1.240,50 €</p>	<p>matt/polirt, Brill. TW/SI 0,02 ct.</p>  <p>R547 B: ca. 1,5 mm, Gr. 48-65 146,00 €</p>	<p>polirt, Brill. TW/SI 0,02 ct.</p>  <p>R723 B: ca. 4 mm, Gr. 48-65 129,00 €</p>
<p>matt/polirt, Brill. TW/SI 0,02 ct.</p>  <p>R702 B: ca. 5 mm, Gr. 48-65 139,50 €</p>	<p>matt/polirt, Brill. TW/SI 0,02 ct.</p>  <p>R720 B: ca. 5 mm, Gr. 48-65 149,00 €</p>	<p>matt/polirt, Brill. TW/SI 0,02 ct.</p>  <p>R728 B: ca. 6,5 mm, Gr. 48-65 139,00 €</p>	<p>matt/polirt, Brill. TW/SI 0,02 ct.</p>  <p>R729 B: ca. 7 mm, Gr. 48-65 179,00 €</p>
<p>matt/gekratzt/polirt, Brill. TW/SI 0,02 ct.</p>  <p>R750 B: ca. 11 mm, Gr. 48-65 179,00 €</p>	<p>matt/gekratzt/polirt, teilweise Gelbgold beschichtet, Brill. TW/SI 0,02 ct.</p>  <p>R751 B: ca. 11 mm, Gr. 48-65 199,00 €</p>	<p>matt/polirt/ gekratzt, Brill. TW/SI 0,02 ct.</p>  <p>R714 B: ca. 5 mm, Ø Ringkopf ca. 13 mm, Gr. 48-65 176,00 €</p>	<p>matt/polirt/ gekratzt, teilweise Gelbgold beschichtet, Brill. TW/SI 0,02 ct.</p>  <p>R715 B: ca. 5 mm, Ø Ringkopf ca. 13 mm, Gr. 48-65 196,50 €</p>
<p>matt/polirt, teilweise Schwarz beschichtet, Brill. TW/SI 0,02 ct.</p>  <p>R522 B: 4 mm, Gr. 48-65 169,00 €</p>	<p>matt/polirt, 585er Gelbgold Brill. TW/SI 0,02 ct.</p>  <p>R523 B: 4 mm, Gr. 48-65 209,50 €</p>	<p>matt/polirt, 585er Roségold Brill. TW/SI 0,02 ct.</p>  <p>R524 B: 4 mm, Gr. 48-65 209,50 €</p>	<p>matt/polirt/graviert</p>  <p>R500 B: ca. 10 mm, Gr. 48-65 76,00 €</p>

<p>matt/polier/gekratz</p>  <p>B: ca. 8 mm, Gr. 48-65</p> <p>R721 99,00 €</p>	<p>matt/polier/ gekratz</p>  <p>B: ca. 1,5 mm, Ø Ringkopf ca. 11 mm, Gr. 48-65</p> <p>R724 79,00 €</p>	<p>poliert/gekratz</p>  <p>B: ca. 8 mm, Gr. 48-65</p> <p>R726 79,00 €</p>	<p>matt/polier</p>  <p>B: ca. 8 mm, Gr. 48-65</p> <p>R736 59,00 €</p>
<p>poliert</p>  <p>B: ca. 8 mm, Gr. 48-65</p> <p>R738 59,00 €</p>	<p>gekratz/polier</p>  <p>B: ca. 8 mm, Gr. 48-65</p> <p>R740 59,00 €</p>	<p>gekratz/polier</p>  <p>B: ca. 2,5 mm, Ringkopf Ø ca. 9 mm, Gr. 48-65</p> <p>R746 64,00 €</p>	<p>matt/polier/gekratz, teilweise Gelbgold beschichtet</p>  <p>B: ca. 8 mm, Gr. 48-65</p> <p>R722 129,00 €</p>
<p>matt/polier/ gekratz, teilweise Gelbgold beschichtet</p>  <p>B: ca. 1,5 mm, Ø Ringkopf ca. 11 mm, Gr. 48-65</p> <p>R725 95,00 €</p>	<p>matt/polier/ gekratz, teilweise Gelbgold beschichtet</p>  <p>B: ca. 8 mm, Gr. 48-65</p> <p>R727 95,00 €</p>	<p>gekratz/polier, teilweise Gelbgold beschichtet</p>  <p>B: ca. 2,5 mm, Ringkopf Ø ca. 9 mm, Gr. 48-65</p> <p>R747 73,00 €</p>	<p>matt/polier, Gelbgold beschichtet</p>  <p>B: ca. 8 mm, Gr. 48-65</p> <p>R737 85,00 €</p>
<p>poliert, Gelbgold beschichtet</p>  <p>B: ca. 8 mm, Gr. 48-65</p> <p>R739 85,00 €</p>	<p>gekratz/polier, Gelbgold beschichtet</p>  <p>B: ca. 8 mm, Gr. 48-65</p> <p>R741 85,00 €</p>	<p>matt/polier, SW-Perle Ø ca. 4 mm</p>  <p>Gr. 48-65</p> <p>R703 104,00 €</p>	<p>matt/polier, SW-Perlen Ø 4/5/7 mm</p>  <p>B: ca. 2 mm, Gr. 48-65</p> <p>R716 159,00 €</p>
<p>matt/polier/gekratz, SW-Perle Ø ca. 6 mm</p>  <p>B: ca. 5 mm, Gr. 48-65</p> <p>R545 85,50 €</p>	<p>matt/polier/gekratz, SW-Perle Ø ca. 7 mm</p>  <p>B: ca. 10 mm, Gr. 48-65</p> <p>R546 92,00 €</p>	<p>matt/polier, SW-Perle Ø ca. 6 mm</p>  <p>B: 5 mm, Gr. 48-62</p> <p>R123 78,50 €</p>	<p>matt/polier, SW-Perle Ø ca. 7 mm</p>  <p>B: 10 mm, Gr. 48-62</p> <p>R124 85,50 €</p>
<p>matt, SW-Perle Ø ca. 7 mm</p>  <p>B: 2 mm, Gr. 48-62</p> <p>R95 85,50 €</p>	<p>matt, SW-Perle Ø ca. 7 mm, Brill. TW/SI 0,016 ct.</p>  <p>B: 2 mm, Gr. 48-62</p> <p>R122 160,00 €</p>	<p>matt/polier, SW-Button-Perle Ø ca. 6 mm</p>  <p>B: 8 mm, Gr. 48-62</p> <p>R147 97,50 €</p>	<p>matt, teilweise Gelb- gold beschichtet, SW-Button-Perle Ø ca. 6 mm</p>  <p>B: 8 mm, Gr. 48-62</p> <p>R148 123,00 €</p>

<p>geschliffen/poliert, SW-Button-Perle Ø ca. 7 mm</p>  <p>R371.5 66,00 €</p> <p>B: 5 mm, Gr. 48-62</p>	<p>geschliffen/poliert, SW-Button-Perle Ø ca. 7 mm</p>  <p>R371.7 69,00 €</p> <p>B: 7 mm, Gr. 48-62</p>	<p>poliert, SW-Perle Ø ca. 4 mm</p>  <p>R730 99,00 €</p> <p>B: ca. 5 mm, Gr. 48-65</p>	<p>matt/poliert, SW-Perle Ø ca. 6 mm</p>  <p>R748 99,00 €</p> <p>B: ca. 5 mm, Gr. 48-65</p>
<p>geschliffen/poliert, Gelbgold beschichtet, SW-Button-Perle Ø ca. 7 mm</p>  <p>R372.5 85,50 €</p> <p>B: 5 mm, Gr. 48-62</p>	<p>geschliffen/poliert, Gelbgold beschichtet, SW-Button-Perle Ø ca. 7 mm</p>  <p>R372.7 92,00 €</p> <p>B: 7 mm, Gr. 48-62</p>	<p>poliert, Gelbgold beschichtet, SW-Perle Ø ca. 4 mm</p>  <p>R731 124,00 €</p> <p>B: ca. 5 mm, Gr. 48-65</p>	<p>matt/poliert, Gelbgold beschichtet, SW-Perle Ø ca. 6 mm</p>  <p>R749 129,00 €</p> <p>B: ca. 5 mm, Gr. 48-65</p>
<p>geschliffen/poliert, Roségold beschichtet, SW-Button-Perle Ø ca. 7 mm</p>  <p>R373.5 85,50 €</p> <p>B: 5 mm, Gr. 48-62</p>	<p>geschliffen/poliert, Roségold beschichtet, SW-Button-Perle Ø ca. 7 mm</p>  <p>R373.7 92,00 €</p> <p>B: 7 mm, Gr. 48-62</p>		
<p>matt/poliert, facettierter Hämatit</p>  <p>R732 69,00 €</p> <p>B: ca. 2,5 mm, Gr. 48-65</p>	<p>matt/poliert, facettierter Hämatit</p>  <p>R734 89,00 €</p> <p>B: ca. 1,5 mm, Ringkopf: Ø ca. 12 mm, Gr. 48-65</p>	<p>matt/poliert, facettierter Granat</p>  <p>R742 69,00 €</p> <p>B: ca. 2,5 mm, Gr. 48-65</p>	<p>matt/poliert, facettierter Granat</p>  <p>R744 89,00 €</p> <p>B: ca. 2,5 mm, Ringkopf Ø ca. 12 mm, Gr. 48-65</p>
<p>matt/poliert, Gelbgold beschichtet, facettierter Hämatit</p>  <p>R733 89,00 €</p> <p>B: ca. 2,5 mm, Gr. 48-65</p>	<p>matt/poliert, Gelbgold beschichtet, facettierter Hämatit</p>  <p>R735 113,00 €</p> <p>B: ca. 1,5 mm, Ringkopf: Ø ca. 12 mm, Gr. 48-65</p>	<p>matt/poliert, teilweise Gelbgold beschichtet, facettierter Granat</p>  <p>R743 89,00 €</p> <p>B: ca. 2,5 mm, Gr. 48-65</p>	<p>matt/poliert, facettierter Granat</p>  <p>R745 113,00 €</p> <p>B: ca. 2,5 mm, Ringkopf Ø ca. 12 mm, Gr. 48-65</p>

matt/graviert,
silk wood braun



B: 8 mm, Gr. 48-71

R409
73,00 €

matt/graviert,
silk wood braun



B: 10 mm, Gr. 48-71

R412
76,00 €

matt/graviert,
silk wood braun



B: 8 mm, Gr. 48-71

R421
73,00 €

matt/graviert,
silk wood braun



B: 10 mm, Gr. 48-71

R424
76,00 €

matt/graviert,
silk wood schwarz



B: 8 mm, Gr. 48-71

R408
73,00 €

matt/graviert,
silk wood schwarz



B: 10 mm, Gr. 48-71

R411
76,00 €

matt/graviert,
silk wood schwarz



B: 8 mm, Gr. 48-71

R420
73,00 €

matt/graviert,
silk wood schwarz



B: 10 mm, Gr. 48-71

R423
76,00 €

matt/graviert,
silk wood
schwarz/braun



B: 8 mm, Gr. 48-71

R410
73,00 €

matt/graviert,
silk wood
schwarz/braun



B: 10 mm, Gr. 48-71

R413
76,00 €

matt/graviert,
silk wood
schwarz/braun



B: 8 mm, Gr. 48-71

R422
73,00 €

matt/graviert,
silk wood
schwarz/braun



B: 10 mm, Gr. 48-71

R425
76,00 €

matt/graviert,
silk wood braun



B: 10 mm, Gr. 48-71

R415
76,00 €

matt/graviert,
silk wood schwarz



B: 10 mm, Gr. 48-71

R414
76,00 €

matt/graviert,
silk wood
schwarz/braun



B: 10 mm, Gr. 48-71

R416
76,00 €



poliert, Gelb- oder Roségold beschichtet



R450 30,50 € R451 49,00 € R452 49,00 €

B: 2 mm, Gr. 48-65

poliert, Gelb- oder Roségold beschichtet



R530 35,00 € R531 53,50 € R532 53,50 €

B: 5 mm, Gr. 48-65

matt/polirt/facettiert, Gelb- oder Roségold beschichtet



R539 39,50 € R540 57,50 € R541 57,50 €

B: 2 mm, Gr. 48-65

matt/polirt/facettiert, Gelb- oder Roségold beschichtet



R542 44,00 € R543 60,50 € R544 60,50 €

B: 5 mm, Gr. 48-65

poliert/geschliffen, Gelb- oder Roségold beschichtet



R533 39,50 € R534 57,50 € R535 57,50 €

B: 2 mm, Gr. 48-65

poliert/geschliffen, Gelb- oder Roségold beschichtet



R536 44,00 € R537 60,50 € R538 60,50 €

B: 5 mm, Gr. 48-65

poliert/gekratzt, Gelb- oder Roségold beschichtet



R471 63,00 € R472 78,50 € R473 78,50 €

B: 2 mm, Gr. 48-65

poliert/gekratzt, Gelb- oder Roségold beschichtet



R474 66,00 € R475 82,50 € R476 82,50 €

B: 2 mm, Gr. 48-65

poliert, Gelb- oder Roségold beschichtet, Zirkonia white



R453.WH 76,00 € R454.WH 95,00 € R455.WH 95,00 €

B: 2 mm, Gr. 48-65

poliert, Gelb- oder Roségold beschichtet, Zirkonia white



R456.WH 69,00 € R457.WH 85,50 € R458.WH 85,50 €

B: 2 mm, Gr. 48-65

poliert, Gelb- oder Roségold beschichtet, Zirkonia white



R462.WH 78,50 € R463.WH 97,50 € R464.WH 97,50 €

B: 2 mm, Gr. 48-65

poliert, Gelb- oder Roségold beschichtet, Zirkonia white



R459.WH 73,00 € R460.WH 92,00 € R461.WH 92,00 €

B: 2 mm, Gr. 48-65

poliert, Gelb- oder Roségold beschichtet, Zirkonia white



R465.WH 63,00 €
R466.WH 78,50 €
R467.WH 78,50 €

B: 2 mm, Gr. 48-65

poliert, Gelb- oder Roségold beschichtet, Zirkonia white



R468.WH 66,00 €
R469.WH 82,50 €
R470.WH 82,50 €

B: 2 mm, Gr. 48-65

poliert, Gelb- oder Roségold beschichtet, SW-Button-Perle Ø ca. 5 mm



R489 63,00 €
R490 78,50 €
R491 78,50 €

B: 2 mm, Gr. 48-65

poliert, Gelb- oder Roségold beschichtet, SW-Button-Perle Ø ca. 6 mm



R492 66,00 €
R493 82,50 €
R494 82,50 €

B: 2 mm, Gr. 48-65

matt/gekratzt, Gelb- oder Roségold beschichtet



R581 44,00 €
R582 60,50 €
R583 60,50 €

B: ca. 6 mm, Gr. 48-65

poliert, Gelb- oder Roségold beschichtet



R584 39,50 €
R585 57,50 €
R586 57,50 €

B: ca. 2 mm, Gr. 48-65

poliert, Gelb- oder Roségold beschichtet



R587 44,00 €
R588 60,50 €
R589 60,50 €

B: ca. 4 mm, Gr. 48-65

poliert, Zirkonia white teilausgefasst, Gelb- oder Roségold beschichtet



R590 59,00 €
R591 76,00 €
R592 76,00 €

B: ca. 2 mm, Gr. 48-65

poliert, Zirkonia white, Gelb- oder Roségold beschichtet



R593 76,00 €
R594 95,00 €
R595 95,00 €

B: ca. 2 mm, Gr. 48-65



matt/poliert, Gelb- oder Roségold beschichtet, Zirkonia white



B: ca. 4 mm,
Gr. 48-65

R550 101,50 €
R551 123,00 €
R552 123,00 €

matt/poliert, Gelb- oder Roségold beschichtet, Zirkonia white



B: ca. 5 mm,
Gr. 48-65

R553 107,00 €
R554 130,00 €
R555 130,00 €

matt/poliert, Gelb- oder Roségold beschichtet, Zirkonia white

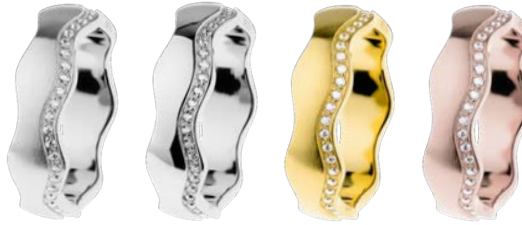

B: ca. 6 mm,
Gr. 48-65

R556 107,00 €
R557 107,00 €
R558 130,00 €
R559 130,00 €

matt/poliert, Gelb- oder Roségold beschichtet, Zirkonia white

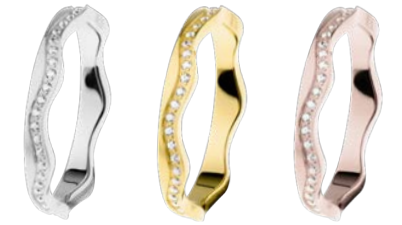

B: ca. 3 mm,
Gr. 48-65

R560 101,50 €
R561 123,00 €
R562 123,00 €

matt/poliert, Gelb- oder Roségold beschichtet



B: ca. 3 mm,
Gr. 48-65

R563 39,50 €
R564 39,50 €
R565 57,50 €
R566 57,50 €

matt/poliert, Gelb- oder Roségold beschichtet

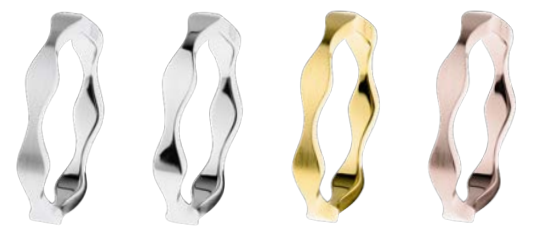

B: ca. 3 mm,
Gr. 48-65

R567 39,50 €
R568 39,50 €
R569 57,50 €
R570 57,50 €

matt/poliert, Gelb- oder Roségold beschichtet, Zirkonia white



B: ca. 4 mm,
Gr. 48-65

R571 101,50 €
R572 123,00 €
R573 123,00 €

matt/poliert, Gelb- oder Roségold beschichtet, Zirkonia white



B: ca. 4 mm,
Gr. 48-65

R574 76,00 €
R575 101,50 €
R576 101,50 €

matt/poliert, Gelb- oder Roségold beschichtet, Zirkonia white



B: ca. 5 mm,
Gr. 48-65

R577 107,00 €
R578 107,00 €
R579 130,00 €
R580 130,00 €

matt/poliert, Zirkonia white, Gelb- oder Roségold beschichtet



B: ca. 4 mm, Gr. 48-65

R708 97,50 €
R709 120,50 €
R710 120,50 €

matt/poliert, Zirkonia white, Gelb- oder Roségold beschichtet



B: ca. 6 mm, Gr. 48-65

R711 104,00 €
R712 126,00 €
R713 126,00 €

<p>matt/polier</p>  <p>B: ca. 3,5 mm, Gr. 48-65</p> <p>R760 33,00 €</p>	<p>matt/polier, Gelbgold beschichtet</p>  <p>B: ca. 3,5 mm, Gr. 48-65</p> <p>R761 53,00 €</p>	<p>matt/polier</p>  <p>B: ca. 6 mm, Gr. 48-65</p> <p>R762 36,00 €</p>	<p>matt/polier, Gelbgold beschichtet</p>  <p>B: ca. 6 mm, Gr. 48-65</p> <p>R763 56,00 €</p>
<p>matt/polier</p>  <p>B: ca. 8 mm, Gr. 48-65</p> <p>R764 39,00 €</p>	<p>matt/polier, Gelbgold beschichtet</p>  <p>B: ca. 8 mm, Gr. 48-65</p> <p>R765 59,00 €</p>	<p>matt/polier, Zirkonia white</p>  <p>B: ca. 3,5 mm, Gr. 48-65</p> <p>R766 75,00 €</p>	<p>matt/polier, Gelbgold beschichtet, Zirkonia white</p>  <p>B: ca. 3,5 mm, Gr. 48-65</p> <p>R767 95,00 €</p>
<p>matt/polier, Zirkonia white</p>  <p>B: ca. 6 mm, Gr. 48-65</p> <p>R768 77,00 €</p>	<p>matt/polier, Gelbgold beschichtet, Zirkonia white</p>  <p>B: ca. 6 mm, Gr. 48-65</p> <p>R769 97,00 €</p>	<p>matt/polier, Zirkonia white</p>  <p>B: ca. 8 mm, Gr. 48-65</p> <p>R770 79,00 €</p>	<p>matt/polier, Gelbgold beschichtet, Zirkonia white</p>  <p>B: ca. 8 mm, Gr. 48-65</p> <p>R771 99,00 €</p>



matt/polirt, Brill. TW/SI 0,016 ct.,
Spiegelankerkette
Ø 1 mm



ca. 3x11 mm, L: 42/45/50 cm,
mit Bajonett-Verschluss Ø 1,8 mm

K740
134,00 €

poliert, Brill. TW/SI 0,016 ct.,
Spiegelankerkette
Ø 1 mm



ca. 3x11 mm, L: 42/45/50 cm,
mit Bajonett-Verschluss Ø 1,8 mm

K741
134,00 €

matt/polirt, Brill. TW/SI 0,02 ct.,
Spiegelankerkette Ø 1 mm



ca. 3x11 mm, L: 42/45/50 cm,
mit Clic-Verschluss Ø 2 mm

K820
185,00 €

matt/polirt,
Brill. TW/SI 0,02ct.,
Drahtseil Ø 0,63 mm



ca. 27x1,5 mm,
L: 42/45/50 cm,
mit Clic-Verschluss Ø 2 mm

K800
185,00 €

matt/polirt,
Brill. TW/SI 0,02 ct.,
Spiegelankerkette Ø 1 mm



ca. 27x1,5 mm,
L: 42/45/50 cm,
mit Clic-Verschluss Ø 2 mm

K801
185,00 €

matt/polirt,
Brill. TW/SI 0,02 ct.,
Drahtseil Ø 0,63 mm



ca. 36x8 mm,
L: 42/45/50 cm,
mit Clic-Verschluss Ø 2 mm

K802
196,50 €

matt/polirt,
Brill. TW/SI 0,02 ct.,
Spiegelankerkette Ø 1 mm



ca. 8x28 mm,
L: 42/45/50 cm,
mit Clic-Verschluss Ø 2 mm

K803
196,50 €

matt/polirt,
Brill. TW/SI 0,02 ct.,
Spiegelankerkette Ø 1 mm

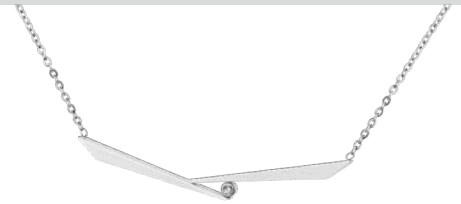

ca. 39x7 mm,
L: 42/45/50 cm,
mit Clic-Verschluss Ø 2 mm

K825
189,00 €

poliert,
Brill. TW/SI 0,02 ct.,
Spiegelankerkette Ø 1 mm



ca. 43x4 mm,
L: 42/45/50 cm,
mit Clic-Verschluss Ø 2 mm

K830
185,00 €

matt/polirt/gekratzt,
Brill. TW/SI 0,02 ct.,
Spiegelankerkette Ø 1 mm



Ø ca. 12 mm,
L: 42/45/50 cm,
mit Clic-Verschluss Ø 2 mm

K831
189,00 €

matt/polirt/gekratzt,
Brill. TW/SI 0,02 ct.,
Spiegelankerkette Ø 1,5 mm



ca. 30x10 mm,
L: 42/45/50 cm,
mit Clic-Verschluss Ø 2 mm

K826
219,00 €

matt/polirt/gekratzt,
Brill. TW/SI 0,02 ct.,
teilweise Gelbgold beschichtet,
Spiegelankerkette Ø 1,5 mm



ca. 30x10 mm,
L: 42/45/50 cm,
mit Clic-Verschluss Ø 2 mm

K827
239,00 €

matt/polier/gekrazt,
Brill. TW/SI 0,02 ct.,
Spiegelankerkette Ø 1 mm



ca. 10x12 mm,
L: 42/45/50 cm,
mit Clic-Verschluss Ø 2 mm

K815
196,50 €

matt/polier/gekrazt,
Spiegelankerkette Ø 1 mm



ca. 10x12 mm,
L: 42/45/50 cm,
mit Clic-Verschluss Ø 2 mm

K812
104,00 €

matt/polier/gekrazt,
Brill. TW/SI 0,02 ct.,
teilweise Gelbgold beschichtet,
Spiegelankerkette Ø 1 mm



ca. 10x12 mm,
L: 42/45/50 cm,
mit Clic-Verschluss Ø 2 mm

K816
209,50 €

matt/polier/gekrazt,
teilweise Gelbgold beschichtet,
Spiegelankerkette Ø 1 mm



ca. 10x12 mm,
L: 42/45/50 cm,
mit Clic-Verschluss Ø 2 mm

K813
116,50 €

matt/polier/gekrazt,
Brill. TW/SI 0,02 ct.,
teilweise Roségold beschichtet,
Spiegelankerkette Ø 1 mm



ca. 10x12 mm,
L: 42/45/50 cm,
mit Clic-Verschluss Ø 2 mm

K817
209,50 €

matt/polier/gekrazt,
teilweise Roségold beschichtet
Spiegelankerkette Ø 1 mm



ca. 10x12 mm,
L: 42/45/50 cm,
mit Clic-Verschluss Ø 2 mm

K814
116,50 €

polier/gekrazt/matt,
Brill. TW/SI 0,02 ct.,
Spiegelankerkette Ø 1 mm



ca. 15x16 mm,
L: 42/45/50 cm,
mit Clic-Verschluss Ø 2 mm

K837
195,00 €

polier/gekrazt/matt,
Spiegelankerkette Ø 1 mm



ca. 15x16 mm,
L: 42/45/50 cm,
mit Clic-Verschluss Ø 2 mm

K836
103,00 €

matt/polier/gekrazt,
Brill. TW/SI 0,02 ct.,
teilweise Gelbgold beschichtet,
Spiegelankerkette Ø 1 mm



ca. 15x16 mm,
L: 42/45/50 cm,
mit Clic-Verschluss Ø 2 mm

K839
208,00 €

matt/polier/gekrazt,
teilweise Gelbgold beschichtet,
Spiegelankerkette Ø 1 mm



ca. 15x16 mm,
L: 42/45/50 cm,
mit Clic-Verschluss Ø 2 mm

K838
115,00 €

matt, teilweise
Gelbgold beschichtet



Ø ca. 5 mm,
mit Bajonett-Verschluss Ø 5 mm

K82
bis 42 cm: 132,50 €

matt



Ø ca. 5 mm,
mit Bajonett-Verschluss Ø 5 mm

K81
bis 42 cm: 116,50 €

poliert/gekratzt,
teilweise Gelbgold
beschichtet



L: 90 cm,
ohne Verschluss

K128
146,00 €

poliert/gekratzt,
teilweise Roségold
beschichtet



L: 90 cm,
ohne Verschluss

K129
146,00 €

poliert/gekratzt



L: 90 cm,
ohne Verschluss

K127
130,00 €

poliert, teilweise
Gelbgold
beschichtet

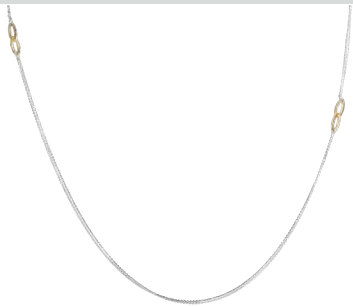

L: 90 cm oder 100 cm,
ohne Verschluss

K833
75,00 €

poliert, teilweise
Gelbgold
beschichtet



L: 90 cm oder 100 cm,
ohne Verschluss

K835
89,00 €

poliert

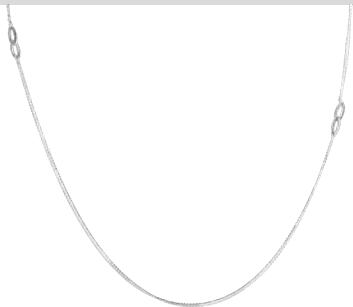

L: 90 cm oder 100 cm,
ohne Verschluss

K832
65,00 €

poliert



L: 90 cm oder 100 cm,
ohne Verschluss

K834
75,00 €

poliert

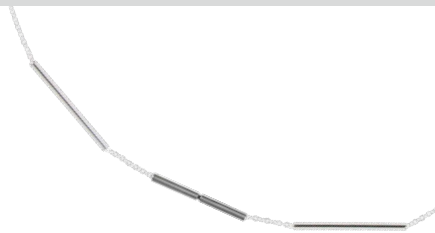

L: 42/45/50 cm,
mit Clic-Verschluss Ø 2 mm

K829
82,00 €

poliert

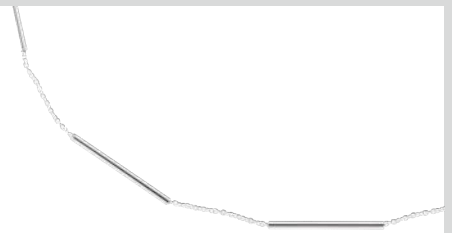

L: 42/45/50 cm,
mit Bajonett-Verschluss Ø 1,8 mm

K828
69,00 €

matt, teilweise
Gelbgold beschichtet,
SW-Perlen Ø ca. 4 mm



Ø ca. 3,5 mm,
mit Bajonett-Verschluss Ø 3,5 mm

K72
bis 42 cm: 143,00 €

matt, SW-Perlen
Ø ca. 4 mm



Ø ca. 3,5 mm,
mit Bajonett-Verschluss Ø 3,5 mm

K71
bis 42 cm: 135,00 €

matt, SW-Perle Ø ca. 7 mm,
Brill. TW/SI 0,016 ct.,
Drahtseil Ø 0,63 mm



Anhänger-Länge ca. 30 mm,
mit Bajonett-Verschluss

K84
bis 50 cm: 157,50 €

matt, Gelbgold beschichtet,
SW-Perle Ø ca. 7 mm,
Drahtseil Ø 0,63 mm



Anhänger-Länge ca. 30 mm,
mit Bajonett-Verschluss

K79
bis 50 cm: 126,00 €

matt, SW-Perle Ø ca. 7 mm,
Drahtseil Ø 0,63 mm



Anhänger-Länge ca. 30 mm,
mit Bajonett-Verschluss

K77
bis 50 cm: 82,50 €

matt, SW-Perlen
Ø ca. 4 mm,
Brill. TW/SI ca. 0,016 ct.



Anhänger Ø ca. 10 mm,
mit Bajonett-Verschluss Ø 3,5 mm

K73
bis 42 cm: 209,50 €

matt, SW-Perlen
Ø ca. 4 mm,
Brill. TW/SI ca. 0,016 ct.



Anhänger ca. 10x10 mm,
mit Bajonett-Verschluss Ø 3,5 mm

K74
bis 42 cm: 209,50 €

matt/poliert,
SW-Perle Ø ca. 7 mm,
Spiegelankerkette Ø 1 mm



Anhänger-Länge ca. 30 mm,
L: 42/45/50 cm, mit Clic-Verschluss Ø 2 mm

K822
116,50 €

matt/poliert,
SW-Perle Ø ca. 6 mm,
Spiegelankerkette Ø 1 mm



Anhänger-Länge ca. 21 mm,
L: 42/45/50 cm, mit Clic-Verschluss Ø 2 mm

K821
101,50 €

matt, SW-Perlen
Ø 4/5/7 mm,
Drahtseil Ø 0,63 mm



ca. 50x2 mm,
L: 42/45/50 cm,
mit Clic-Verschluss Ø 2 mm

K823
189,00 €

matt, SW-Perlen
Ø 4/5/7 mm,
Spiegelankerkette Ø 1,5 mm



ca. 50x2 mm,
L: 42/45/50 cm,
mit Clic-Verschluss Ø 2 mm

K824
189,00 €

matt/poliert,
SW-Perle Ø ca. 4 mm,
Drahtseil Ø 0,63 mm



ca. 27x1,5 mm,
L: 42/45/50 cm,
mit Clic-Verschluss Ø 2 mm

K818
104,00 €

matt/poliert,
SW-Perle Ø ca. 4 mm,
Spiegelankerkette Ø 1 mm



ca. 27x1,5 mm,
L: 42/45/50 cm,
mit Clic-Verschluss Ø 2 mm

K819
104,00 €

matt/poliert,
facettierter Hämatit,
Spiegelankerkette Ø 1,5 mm



Ø ca. 12/19 mm,
L: ca. 42, 45, 50 cm,
mit Clic-Verschluss Ø 2 mm

K840
115,00 €

matt/poliert,
facettierter Granat,
Spiegelankerkette Ø 1,5 mm



Ø ca. 12/19 mm,
L: ca. 42, 45, 50 cm,
mit Clic-Verschluss Ø 2 mm

K843
115,00 €

matt/poliert, teilweise
Gelbgold beschichtet,
facettierter Hämatit,
Spiegelankerkette Ø 1,5 mm



Ø ca. 12/19 mm,
L: ca. 42, 45, 50 cm,
mit Clic-Verschluss Ø 2 mm

K841
135,00 €

matt/poliert, teilweise
Gelbgold beschichtet,
facettierter Granat,
Spiegelankerkette Ø 1,5 mm



Ø ca. 12/19 mm,
L: ca. 42, 45, 50 cm,
mit Clic-Verschluss Ø 2 mm

K844
135,00 €

matt/poliert,
Gelbgold beschichtet,
facettierter Hämatit,
Spiegelankerkette Ø 1,5 mm



Ø ca. 12/19 mm,
L: ca. 42, 45, 50 cm,
mit Clic-Verschluss Ø 2 mm

K842
145,00 €

matt/poliert,
Gelbgold beschichtet,
facettierter Granat,
Spiegelankerkette Ø 1,5 mm



Ø ca. 12/19 mm,
L: ca. 42, 45, 50 cm,
mit Clic-Verschluss Ø 2 mm

K845
145,00 €

matt/poliert,
facettierter
Hämatit,
Spiegelankerkette
Ø 1,5 mm



L: variabel verstellbar
(max. 78 cm),
Hämatit: L. ca. 3,5 cm
ohne Verschluss

K846
59,00 €

matt/poliert,
Gelbgold
beschichtet,
facettierter
Hämatit,
Spiegelankerkette
Ø 1,5 mm



L: variabel verstellbar
(max. 78 cm),
Hämatit: L. ca. 3,5 cm
ohne Verschluss

K847
95,00 €

matt/poliert,
facettierter
Granat,
Spiegelankerkette
Ø 1,5 mm



L: variabel verstellbar
(max. 78 cm),
Granat: L. ca. 3,5 cm
ohne Verschluss

K848
59,00 €

matt/poliert,
Gelbgold
beschichtet,
facettierter
Granat,
Spiegelankerkette
Ø 1,5 mm



L: variabel verstellbar
(max. 78 cm),
Granat: L. ca. 3,5 cm
ohne Verschluss

K849
95,00 €

matt, facettierter Hämatit
Ø ca. 2,5 mm



Preis bis 50 cm Länge,
mit Clic-Verschluss Ø 2 mm

K850
89,00 €

matt, teilweise
Gelbgold
beschichtet,
facettierter Hämatit
Ø ca. 2,5 mm



Preis bis 50 cm Länge,
mit Clic-Verschluss Ø 2 mm

K851
99,00 €

matt, facettierter Granat
Ø ca. 2,5 mm

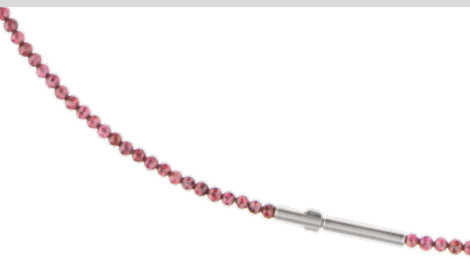

Preis bis 50 cm Länge,
mit Clic-Verschluss Ø 2 mm

K852
89,00 €

matt, teilweise
Gelbgold
beschichtet,
facettierter Granat
Ø ca. 2,5 mm

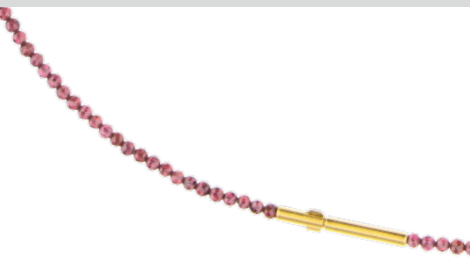

Preis bis 50 cm Länge,
mit Clic-Verschluss Ø 2 mm

K853
99,00 €

matt, facettierter Peridot
Ø ca. 2,5 mm



Preis bis 50 cm Länge,
mit Clic-Verschluss Ø 2 mm

K854
89,00 €

matt, teilweise
Gelbgold
beschichtet,
facettierter Peridot
Ø ca. 2,5 mm



Preis bis 50 cm Länge,
mit Clic-Verschluss Ø 2 mm

K855
99,00 €



matt, Leder



HB
DB

Ø ca. 6 mm,
mit Magnetverschluss groß mit Gewinde

K111.HB K111.DB K111.SW
bis 60 cm: je 88,00 €

Königskette

matt/polier



Ø ca. 5 mm,
mit Magnetverschluss groß mit Gewinde

K136
bis 45 cm: 134,00 €

Königskette

matt/polier



Ø ca. 9 mm,
mit Magnetverschluss groß mit Gewinde

K105
bis 45 cm: 148,50 €

Strickkette

matt



Ø ca. 7 mm,
mit Magnetverschluss groß mit Gewinde

K133
bis 45 cm: 95,00 €

matt/polier



Ø ca. 12 mm,
mit Magnetverschluss groß mit Gewinde

K134
bis 45 cm: 257,50 €

Zopf

matt/polier

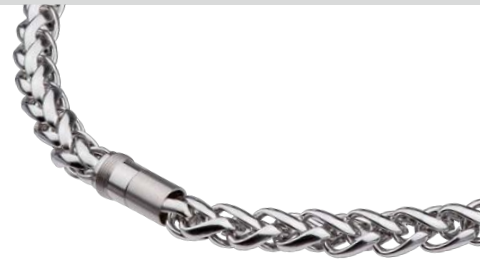

Ø ca. 8 mm,
mit Magnetverschluss groß mit Gewinde

K140
bis 45 cm: 130,00 €

Olivenkette

matt/polier



Ø ca. 12 mm,
mit Magnetverschluss groß mit Gewinde

K146
bis 45 cm: 212,00 €

matt/polier



Ø ca. 8 mm,
mit Magnetverschluss groß mit Gewinde

K191
bis 45 cm: 148,50 €

Königskette

zweifarbig, matt/polier,
teilweise Gelbgold
beschichtet

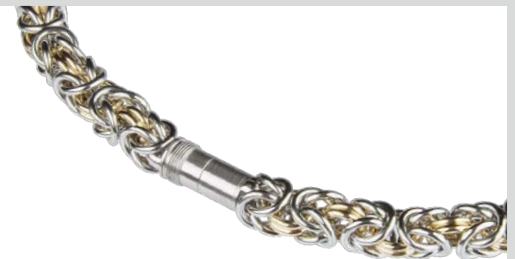

Ø ca. 9 mm,
mit Magnetverschluss groß mit Gewinde

K143
bis 45 cm: 235,50 €

Olivenkette

zweifarbig, matt/polier,
teilweise Gelbgold
beschichtet



Ø ca. 12 mm,
mit Magnetverschluss groß mit Gewinde

K147
bis 45 cm: 235,50 €

Königskette

zweifarbig, matt/polier,
teilweise Roségold
beschichtet

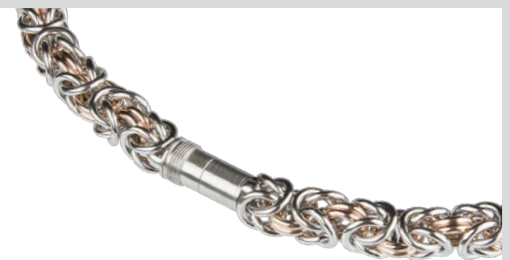

Ø ca. 9 mm,
mit Magnetverschluss groß mit Gewinde

K144
bis 45 cm: 235,50 €

Olivenkette

zweifarbig, matt/polier,
teilweise Roségold
beschichtet



Ø ca. 12 mm,
mit Magnetverschluss groß mit Gewinde

K148
bis 45 cm: 235,50 €

Königskette

zweifarbig, matt/
polier, teilweise Schwarz
beschichtet



Ø ca. 9 mm,
mit Magnetverschluss groß mit Gewinde

K145
bis 45 cm: 235,50 €

matt/poliert



Ø ca. 5 mm,
mit Magnetverschluss klein ohne Gewinde

K189
bis 50 cm: 101,50 €

matt/poliert

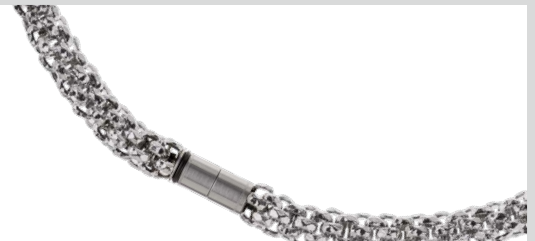

Ø ca. 8 mm,
mit Magnetverschluss klein ohne Gewinde

K188
bis 45 cm: 148,50 €

Königskette

matt/poliert

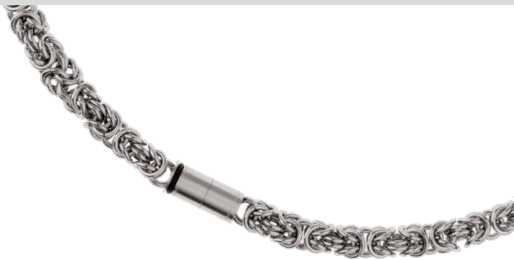

Ø ca. 5 mm,
mit Magnetverschluss klein ohne Gewinde

K184
bis 45 cm: 134,00 €

antik-matt



Ø ca. 6 mm,
mit Magnetverschluss klein ohne Gewinde

K194
bis 50 cm: 97,50 €

poliert



Ø ca. 6,5 mm,
mit Magnetverschluss klein ohne Gewinde

K195
bis 45 cm: 235,50 €

Königskette

zweifarbige, matt/poliert,
teilweise Gelbgold
beschichtet



Ø ca. 5 mm,
mit Magnetverschluss klein ohne Gewinde

K185
bis 45 cm: 212,00 €

Königskette

zweifarbige, matt/poliert,
teilweise Roségold
beschichtet

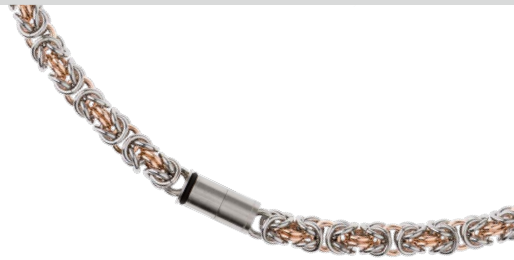

Ø ca. 5 mm,
mit Magnetverschluss klein ohne Gewinde

K186
bis 45 cm: 212,00 €

Königskette

zweifarbige, matt/poliert,
teilweise Schwarz
beschichtet



Ø ca. 5 mm,
mit Magnetverschluss klein ohne Gewinde

K187
bis 45 cm: 212,00 €

antik-matt

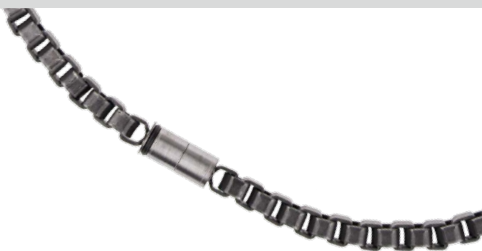

Ø ca. 5 mm,
mit Magnetverschluss klein ohne Gewinde

K196
bis 50 cm: 97,50 €

matt/poliert,
(AK45C+AN759+
AN1040+AN1041)



L: 42/45/50 cm,
mit Clic-Verschluss
Ø 2 mm und
Magnetverschluss klein
ohne Gewinde

K203
186,00 €

matt/poliert,
teilweise Gelbgold
beschichtet
(AK45C+AN759+
AN1040+AN1041)

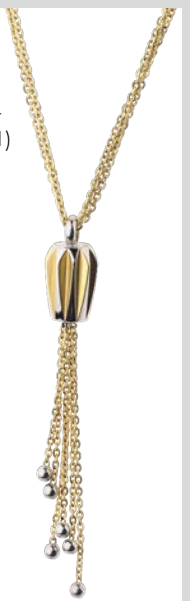

L: 42/45/50 cm,
mit Clic-Verschluss
Ø 2 mm und
Magnetverschluss klein
ohne Gewinde

K204
222,00 €

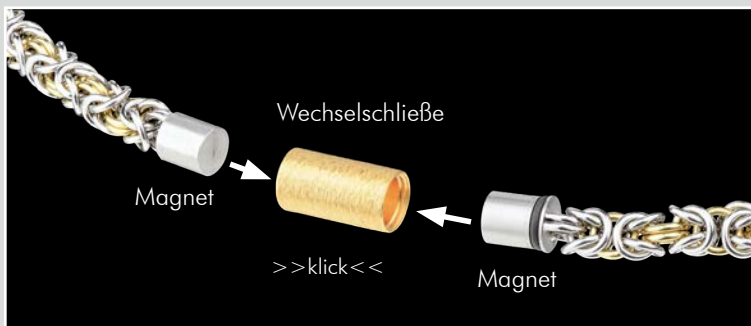

Wechselschließe

Magnet

>>klick<<

Magnet

SW-Perlen



Ø ca. 6 mm,
mit Magnetverschluss klein ohne Gewinde

K182
bis 45 cm: 176,00 €

SW-Perlen



Ø ca. 8 mm,
mit Magnetverschluss klein ohne Gewinde

K183
bis 45 cm: 299,00 €

matte Onyx-Perlen



Ø ca. 6 mm,
mit Magnetverschluss klein ohne Gewinde

K180
bis 50 cm: 97,50 €

matte Onyx-Perlen



Ø ca. 8 mm,
mit Magnetverschluss klein ohne Gewinde

K181
bis 50 cm: 104,00 €

matte Onyx-Linsen

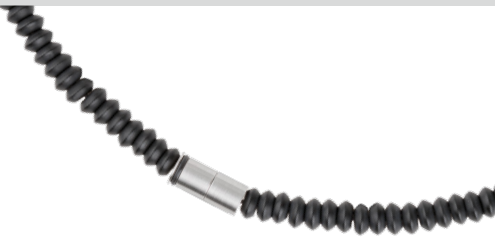

Ø ca. 6 mm,
mit Magnetverschluss klein ohne Gewinde

K192
bis 50 cm: 97,50 €

matte Onyx-Linsen



Ø ca. 8 mm,
mit Magnetverschluss klein ohne Gewinde

K193
bis 50 cm: 104,00 €

matte Silberauge-Perlen



Ø ca. 6 mm,
mit Magnetverschluss klein ohne Gewinde

K197
bis 50 cm: 97,00 €

matte Silberauge-Perlen



Ø ca. 8 mm,
mit Magnetverschluss klein ohne Gewinde

K198
bis 50 cm: 105,00 €

matte Holzjaspis-Perlen



Ø ca. 6 mm,
mit Magnetverschluss klein ohne Gewinde

K199
bis 50 cm: 97,00 €

matte Holzjaspis-Perlen

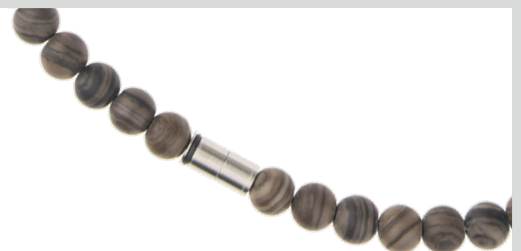

Ø ca. 8 mm,
mit Magnetverschluss klein ohne Gewinde

K200
bis 50 cm: 105,00 €

matte Sodalith-Perlen



Ø ca. 6 mm,
mit Magnetverschluss klein ohne Gewinde

K201
bis 50 cm: 97,00 €

matte Sodalith-Perlen

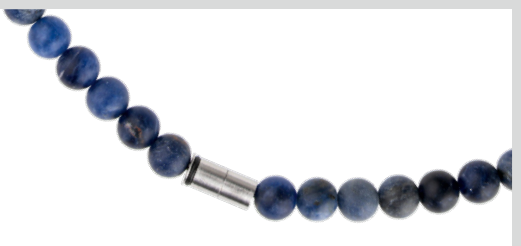

Ø ca. 8 mm,
mit Magnetverschluss klein ohne Gewinde

K202
bis 50 cm: 105,00 €

matt/graviert,
silk wood braun,
Lederband
dunkelbraun



ca. 17x34 mm,
mit Bajonett-
Verschluss
Ø 2,7 mm

K606.B
bis 60 cm: 95,00 €

matt/graviert,
silk wood braun,
Lederband
dunkelbraun



ca. 17x34 mm,
mit Bajonett-
Verschluss
Ø 2,7 mm

K609.B
bis 60 cm: 95,00 €

matt/graviert,
silk wood braun,
Lederband
dunkelbraun



Ø ca. 28 mm,
mit Bajonett-
Verschluss
Ø 2,7 mm

K656.B
bis 60 cm: 95,00 €

matt/graviert,
silk wood braun,
Lederband
dunkelbraun



Ø ca. 28 mm,
mit Bajonett-
Verschluss
Ø 2,7 mm

K668.B
bis 60 cm: 95,00 €

matt/graviert,
silk wood braun,
Lederband
dunkelbraun



ca. 17x34 mm,
mit Bajonett-
Verschluss
Ø 2,7 mm

K624.B
bis 60 cm: 95,00 €

matt/graviert,
silk wood braun,
Lederband
dunkelbraun



Ø ca. 28 mm,
mit Bajonett-
Verschluss
Ø 2,7 mm

K677.B
bis 60 cm: 95,00 €

matt/graviert,
silk wood
schwarz,
Lederband
schwarz



ca. 17x34 mm,
mit Bajonett-
Verschluss
Ø 2,7 mm

K624.S
bis 60 cm: 95,00 €

matt/graviert,
silk wood
schwarz,
Lederband
schwarz



Ø ca. 28 mm,
mit Bajonett-
Verschluss
Ø 2,7 mm

K677.S
bis 60 cm: 95,00 €

poliert/graviert,
Schwarz beschichtet,
silk wood
braun,
Lederband
dunkelbraun



ca. 17x34 mm,
mit Bajonett-
Verschluss
Ø 2,7 mm

K602.B
bis 60 cm: 107,00 €

poliert/graviert,
Schwarz beschichtet,
silk wood
braun,
Lederband
dunkelbraun



Ø ca. 28 mm,
mit Bajonett-
Verschluss
Ø 2,7 mm

K652.B
bis 60 cm: 107,00 €

matt/graviert,
silk wood
schwarz,
Lederband
schwarz



ca. 17x34 mm,
mit Bajonett-
Verschluss
Ø 2,7 mm

K600.S
bis 60 cm: 95,00 €

matt/graviert,
silk wood
schwarz,
Lederband
schwarz



Ø ca. 28 mm,
mit Bajonett-
Verschluss
Ø 2,7 mm

K679.S
bis 60 cm: 95,00 €

matt/graviert,
silk wood
schwarz,
Lederband
schwarz



Ø ca. 28 mm,
mit Bajonett-
Verschluss
Ø 2,7 mm

K681.S
bis 60 cm: 95,00 €



matt/poliert/gemustert
(A601, A602, E632, EH01,
Kettenstück+ANV16)



inkl. Verpackung



Länge Collier: ca. 50 cm,
Länge Armband: ca. 17-23 cm,
Länge Ohrschmuck: ca. 4 cm

S001
156,00 €

matt/poliert/gemustert, Kunstperlen
Ø ca. 8 mm (A603, A608, E632, EH01,
Kettenstück+ANV16)



inkl. Verpackung



Länge Collier: ca. 50 cm,
Länge Armband: ca. 17-23 cm,
Länge Ohrschmuck: ca. 4 cm

S002
182,00 €

matt/poliert/gemustert, Onyx- u. Spinell-Perlen
Ø ca. 6/5 mm (A605, A600, E632, EH02,
Kettenstück+ANV16)



inkl. Verpackung



Länge Collier: ca. 50 cm,
Länge Armband: ca. 17-23 cm,
Länge Ohrschmuck: ca. 5,5 cm

S003
182,00 €

matt/poliert/gemustert, teilweise Gelbgold
beschichtet (A608, A606, E632, EH03,
Kettenstück+ANV17)



inkl. Verpackung



Länge Collier: ca. 50 cm,
Länge Armband: ca. 17-23 cm,
Länge Ohrschmuck: ca. 5 cm

S004
166,00 €

matt/poliert/gemustert, teilweise Gelbgold
beschichtet, Kunstperlen Ø ca. 6 mm
(A604, A615, E633, EH04,
Kettenstück+ANV17)



inkl. Verpackung



Länge Collier: ca. 50 cm,
Länge Armband: ca. 17-23 cm,
Länge Ohrschmuck: ca. 4,5 cm

S005
212,00 €

matt/poliert/gemustert, teilweise Gelbgold
beschichtet, Onyx- u. Spinell-Perlen Ø ca. 6/5 mm
(A605, A607, E633, EH05,
Kettenstück+ANV17)



inkl. Verpackung



Länge Collier: ca. 50 cm,
Länge Armband: ca. 17-23 cm,
Länge Ohrschmuck: ca. 8 cm

S006
212,00 €

matt/poliert/gemustert, Gelbgold
beschichtet (A609, A611, E633, EH06,
Kettenstück+ANV17)



inkl. Verpackung



Länge Collier: ca. 50 cm,
Länge Armband: ca. 17-23 cm,
Länge Ohrschmuck: ca. 4 cm

S007
196,00 €



poliert/gemustert



L: ca. 17-23 cm

A600
39,00 €

poliert/gemustert



L: ca. 17-23 cm

A601
39,00 €

poliert/gemustert



L: ca. 17-23 cm

A602
39,00 €

poliert/gemustert,
Kunstperlen Ø ca. 8 mm



L: ca. 17-23 cm

A603
65,00 €

poliert/gemustert,
Kunstperlen Ø ca. 6 mm



L: ca. 17-23 cm

A604
65,00 €

poliert/gemustert,
Onyx- und Spinell-Perlen
Ø ca. 6/5 mm



L: ca. 17-23 cm

A605
65,00 €

poliert/gemustert



L: ca. 17-23 cm

A606
39,00 €

poliert/gemustert,
Gelbgold beschichtet



L: ca. 17-23 cm

A607
49,00 €

poliert/gemustert



L: ca. 17-23 cm

A608
39,00 €

poliert/gemustert,
Gelbgold beschichtet



L: ca. 17-23 cm

A609
49,00 €

geriffelt/poliert/gemustert



L: ca. 17-23 cm

A610
39,00 €

geriffelt/poliert/gemustert,
Gelbgold beschichtet



L: ca. 17-23 cm

A611
49,00 €

geriffelt/polirt/gemustert



L: ca. 17-23 cm

A612
39,00 €

geriffelt/polirt/gemustert,
Gelbgold beschichtet



L: ca. 17-23 cm

A613
49,00 €

polirt/gemustert



L: ca. 17-23 cm

A614
39,00 €

polirt/gemustert,
Gelbgold beschichtet



L: ca. 17-23 cm

A615
49,00 €

geriffelt/polirt



Länge Eihänger
ca. 3 cm

EH01
10,00 €

polirt



Länge Eihänger
ca. 4,5 cm

EH02
10,00 €

polirt, Gelbgold
beschichtet



Länge Eihänger
ca. 4 cm

EH03
12,00 €

geriffelt/polirt,
Gelbgold
beschichtet



Länge Eihänger
ca. 3,5 cm

EH04
12,00 €

polirt, Gelbgold
beschichtet



Länge Eihänger
ca. 7 cm

EH05
12,00 €

geriffelt/polirt,
Gelbgold
beschichtet



Länge Eihänger
ca. 3 cm

EH06
12,00 €

gemustert/polirt



Ø ca. 19 mm

ANV16
19,00 €

gemustert/polirt,
Gelbgold
beschichtet



Ø ca. 19 mm

ANV17
22,00 €

evia-KETTEN

polirt,
Zirkonia white teilausgefasset,
Spiegelankerkette Ø 1,5 mm



Ø ca. 25 mm, L: 42/45/50 cm,
mit Clic-Verschluss Ø 2 mm

K790
129,00 €

polirt, Gelbgold beschichtet,
Zirkonia white teilausgefasset,
Spiegelankerkette Ø 1,5 mm



Ø ca. 25 mm, L: 42/45/50 cm,
mit Clic-Verschluss Ø 2 mm

K791
145,00 €

polirt, Roségold beschichtet,
Zirkonia white teilausgefasset,
Spiegelankerkette Ø 1,5 mm



Ø ca. 25 mm, L: 42/45/50 cm,
mit Clic-Verschluss Ø 2 mm

K792
145,00 €

<p>matt/polirt, Brill. TW/SI 0,035 ct.</p>  <p>ca. 3x25 mm, Kettenöffnung 2 mm</p> <p>AN565 182,00 €</p>	<p>polirt, Brill. TW/SI 0,035 ct.</p>  <p>ca. 3x25 mm, Kettenöffnung 2 mm</p> <p>AN566 182,00 €</p>	<p>matt/polirt, Brill. TW/SI 0,065 ct.</p>  <p>ca. 5x25 mm, Kettenöffnung 3 mm</p> <p>AN567 299,00 €</p>	<p>polirt, Brill. TW/SI 0,065 ct.</p>  <p>ca. 5x25 mm, Kettenöffnung 3 mm</p> <p>AN568 299,00 €</p>
<p>matt/polirt, Brill. TW/SI 0,065 ct.</p>  <p>ca. 4x23 mm, Kettenöffnung 2,8 mm</p> <p>AN909 299,00 €</p>	<p>matt, Brill. TW/SI 0,016 ct.</p>  <p>Ø ca. 6 mm, Kettenöffnung 2,3 mm</p> <p>AN282 104,00 €</p>	<p>matt, Brill. TW/SI 0,035 ct.</p>  <p>Ø ca. 6 mm, Kettenöffnung 2,3 mm</p> <p>AN283 187,50 €</p>	<p>matt, Brill. TW/SI 0,065 ct.</p>  <p>Ø ca. 6 mm, Kettenöffnung 2,3 mm</p> <p>AN284 299,00 €</p>
<p>matt/polirt, Brill. TW/SI 0,02 ct.</p>  <p>Ø ca. 12 mm, Kettenöffnung 2,7 mm</p> <p>AN860 139,50 €</p>	<p>matt/polirt, Brill. TW/SI 0,035 ct.</p>  <p>Ø ca. 15 mm, Kettenöffnung 2,9 mm</p> <p>AN861 182,00 €</p>	<p>matt/polirt/ gekratzt, Brill. TW/SI 0,02 ct.</p>  <p>ca. 16x27 mm, Kettenöffnung 3 mm</p> <p>AN885 139,50 €</p>	<p>matt/polirt, Brill. TW/SI 0,02 ct.</p>  <p>ca. 7x20 mm, Kettenöffnung 2 mm</p> <p>AN900 139,50 €</p>
<p>matt/polirt, Brill. TW/SI 0,02 ct.</p>  <p>ca. 8x19 mm, Kettenöffnung 2,1 mm</p> <p>AN990 135,00 €</p>	<p>matt/gekratzt, Brill. TW/SI 0,02 ct.</p>  <p>ca. 8x8 mm, Kettenöffnung 2 mm</p> <p>AN897 130,00 €</p>	<p>matt/gekratzt/ polirt, Brill. TW/SI 0,02 ct.</p>  <p>ca. 14x17 mm, Kettenöffnung 2,1 mm</p> <p>AN937 176,00 €</p>	<p>matt/polirt, Brill. TW/SI 0,02 ct.</p>  <p>ca. 7x18 mm, Kettenöffnung 2,1 mm</p> <p>AN1002 138,00 €</p>
<p>matt/polirt/ gekratzt, Brill. TW/SI 0,02 ct.</p>  <p>Ø ca. 18 mm, Kettenöffnung 2,3 mm</p> <p>AN940 176,00 €</p>	<p>matt/gekratzt/ polirt, Brill. TW/SI 0,035 ct.</p>  <p>Ø ca. 19 mm, Kettenöffnung 2,1 mm</p> <p>AN1029 179,00 €</p>	<p>matt/polirt/ gekratzt, teilweise Gelbgold beschichtet, Brill. TW/SI 0,02 ct.</p>  <p>Ø ca. 18 mm, Kettenöffnung 2,3 mm</p> <p>AN941 196,50 €</p>	<p>matt/gekratzt/ polirt, teilweise Gelbgold beschichtet, Brill. TW/SI 0,035 ct.</p>  <p>Ø ca. 19 mm, Kettenöffnung 2,1 mm</p> <p>AN1030 199,00 €</p>
<p>matt/gekratzt/ polirt, teilweise Gelbgold beschichtet, Brill. TW/SI 0,02 ct.</p>  <p>ca. 14x17 mm, Kettenöffnung 2,1 mm</p> <p>AN938 196,50 €</p>	<p>matt/polirt, 585er Gelbgold, Brill. TW/SI 0,02 ct.</p>  <p>Ø 10 mm, Kettenöffnung 2,3 mm</p> <p>AN846 176,00 €</p>	<p>matt/polirt, 585er Gelbgold, Brill. TW/SI 0,02 ct.</p>  <p>Ø 10 mm, Kettenöffnung 2,8 mm</p> <p>AN850 196,50 €</p>	<p>matt/gekratzt, 585er Gelbgold, Brill. TW/SI 0,02 ct.</p>  <p>ca. 8x8 mm, Kettenöffnung 2 mm</p> <p>AN898 185,00 €</p>

<p>matt/gekratzt/ poliert, teilweise Roségold beschichtet, Brill. TW/SI 0,02 ct.</p>  <p>ca. 14x17 mm, Kettenöffnung 2,1 mm</p> <p>AN939 196,50 €</p>	<p>matt/polirt, 585er Roségold, Brill. TW/SI 0,02 ct.</p>  <p>Ø 10 mm, Kettenöffnung 2,3 mm</p> <p>AN847 176,00 €</p>	<p>matt/polirt, 585er Roségold, Brill. TW/SI 0,02 ct.</p>  <p>Ø 10 mm, Kettenöffnung 2,8 mm</p> <p>AN851 196,50 €</p>	<p>matt/gekratzt, 585er Roségold, Brill. TW/SI 0,02 ct.</p>  <p>ca. 8x8 mm, Kettenöffnung 2 mm</p> <p>AN899 185,00 €</p>
<p>matt/polirt, teilweise Schwarz beschichtet, Brill. TW/SI 0,02 ct.</p>  <p>Ø 10 mm, Kettenöffnung 2,3 mm</p> <p>AN843 134,00 €</p>	<p>matt/polirt, teilweise Schwarz beschichtet, Brill. TW/SI 0,02 ct.</p>  <p>Ø 10 mm, Kettenöffnung 2,8 mm</p> <p>AN845 134,00 €</p>	<p>matt/polirt/ gekratzt</p>  <p>ca. 16x27 mm, Kettenöffnung 3 mm</p> <p>AN884 66,00 €</p>	<p>matt/ polirt/ gekratzt</p>  <p>ca. 12x35 mm, Kettenöffnung Ø 5 mm</p> <p>AN942 79,00 €</p>
<p>matt/ gekratzt/ poliert</p>  <p>ca. 14x17 mm, Kettenöffnung 2,1 mm</p> <p>AN934 78,50 €</p>	<p>matt/polirt/ gekratzt</p>  <p>Ø ca. 12 mm, Kettenöffnung 2,3 mm</p> <p>AN944 49,00 €</p>	<p>matt/polirt/ gekratzt</p>  <p>Ø ca. 19 mm, Kettenöffnung 3,8 mm</p> <p>AN946 55,00 €</p>	<p>matt/gekratzt/ poliert</p>  <p>Ø ca. 26 mm, Kettenöffnung 4,5 mm</p> <p>AN948 65,00 €</p>
<p>matt/polirt</p>  <p>ca. 10x30 mm, Kettenöffnung 3 mm</p> <p>AN992 49,00 €</p>	<p>polirt/gekratzt/matt</p>  <p>ca. 50x55 mm, Kettenöffnung 5 mm</p> <p>AN994 104,00 €</p>	<p>matt/polirt/ gekratzt</p>  <p>ca. 20x20 mm, Kettenöffnung 2,1 mm</p> <p>AN996 69,00 €</p>	<p>matt/polirt/ gekratzt</p>  <p>ca. 35x35 mm, Kettenöffnung 2,8 mm</p> <p>AN998 85,00 €</p>
<p>matt/polirt/ gekratzt</p>  <p>ca. 55x55 mm, Kettenöffnung 4,6 mm</p> <p>AN1000 99,00 €</p>	<p>gekratzt/polirt</p>  <p>Ø ca. 17 mm, Kettenöffnung 2,1 mm</p> <p>AN1017 49,00 €</p>	<p>gekratzt/polirt</p>  <p>Ø ca. 39 mm, Kettenöffnung 3,6 mm</p> <p>AN1019 75,00 €</p>	<p>matt/polirt/ gekratzt</p>  <p>Ø ca. 20 mm, Kettenöffnung 3 mm</p> <p>AN1025 75,00 €</p>
<p>matt/polirt/ gekratzt</p>  <p>Ø ca. 40 mm, Kettenöffnung 3,5 mm</p> <p>AN1027 99,00 €</p>	<p>matt/polirt/ gekratzt, teilweise Gelbgold beschichtet</p>  <p>ca. 16x27 mm, Kettenöffnung 3 mm</p> <p>AN886 73,00 €</p>	<p>matt/polirt/ gekratzt, teilweise Gelbgold beschichtet</p>  <p>ca. 12x35 mm, Kettenöffnung Ø 5 mm</p> <p>AN943 99,00 €</p>	<p>matt/gekratzt/ poliert, teilweise Gelbgold beschichtet</p>  <p>ca. 14x17 mm, Kettenöffnung 2,1 mm</p> <p>AN935 104,00 €</p>

matt/polirt,
teilweise Gelbgold
beschichtet



Ø ca. 19 mm,
Kettenöffnung 2,9 mm

AN904
104,00 €

matt/polirt,
teilweise
Gelbgold
beschichtet



Ø ca. 26 mm,
Kettenöffnung 2,1 mm

AN907
116,50 €

matt/polirt/
gekratzt, teilweise
Gelbgold
beschichtet



Ø ca. 12 mm,
Kettenöffnung 2,3 mm

AN945
59,00 €

matt/polirt/
gekratzt, teilweise
Gelbgold
beschichtet



Ø ca. 19 mm,
Kettenöffnung 3,8 mm

AN947
69,00 €

matt/polirt/
gekratzt, teilweise
Gelbgold
beschichtet



Ø ca. 26 mm,
Kettenöffnung 4,5 mm

AN949
85,00 €

matt/gekratzt/polirt,
teilweise Gelbgold
beschichtet



ca. 50x55 mm,
Kettenöffnung 5 mm

AN995
125,00 €

gekratzt/geschliffen,
teilweise Gelbgold
beschichtet



Ø ca. 17 mm,
Kettenöffnung 2,1 mm

AN1018
62,00 €

gekratzt/geschliffen,
teilweise Gelbgold
beschichtet



Ø ca. 39 mm,
Kettenöffnung 3,6 mm

AN1020
99,00 €

matt/polirt/
gekratzt, teilweise
Gelbgold
beschichtet



Ø ca. 20 mm,
Kettenöffnung 3 mm

AN1026
85,00 €

matt/polirt/
gekratzt,
teilweise
Gelbgold
beschichtet



Ø ca. 40 mm,
Kettenöffnung 3,5 mm

AN1028
119,00 €

matt/polirt,
Gelbgold
beschichtet



ca. 10x30 mm,
Kettenöffnung 3 mm

AN993
65,00 €

matt/polirt/
gekratzt,
Gelbgold
beschichtet



ca. 20x20 mm,
Kettenöffnung 2,1 mm

AN997
85,00 €

matt/polirt/
gekratzt,
Gelbgold
beschichtet



ca. 35x35 mm,
Kettenöffnung 2,8 mm

AN999
109,00 €

matt/polirt/
gekratzt,
Gelbgold
beschichtet



ca. 55x55 mm,
Kettenöffnung 4,6 mm

AN1001
139,00 €

matt/polirt/
gekratzt,
teilweise Roségold
beschichtet



ca. 16x27 mm,
Kettenöffnung 3 mm

AN887
73,00 €

matt/gekratzt/
polirt, teilweise
Roségold beschichtet



ca. 14x17 mm,
Kettenöffnung 2,1 mm

AN936
104,00 €

matt/
polirt,
SW-Perle
Ø ca. 8 mm



ca. 17x29 mm,
Kettenöffnung 6 mm

AN134
134,00 €

matt/
polirt,
SW-Perle
Ø ca. 7 mm



Ø ca. 19 mm,
Kettenöffnung 4 mm

AN218
88,00 €

geschliffen/
polirt, SW-
Button-Perle
Ø ca. 8 mm



H: ca. 17 mm,
Kettenöffnung 3,8 mm

AN420
56,00 €

geschliffen/
polirt, SW-
Button-Perle
Ø ca. 10 mm



H: ca. 20 mm,
Kettenöffnung 4,7 mm

AN423
78,50 €

matt/polirt/
gekratzt,
SW-Perle
Ø ca. 5 mm



Ø ca. 17 mm,
Kettenöffnung 2,1 mm

AN950
69,00 €

matt/polirt/
gekratzt,
SW-Perle
Ø ca. 7 mm



Ø ca. 26 mm,
Kettenöffnung 3,5 mm

AN952
85,00 €

matt/polirt/
gekratzt,
SW-Perle
Ø ca. 7 mm



Ø ca. 26 mm,
Kettenöffnung 3,5 mm

AN954
129,00 €

polirt,
SW-Perle
Ø ca. 6 mm



ca. 7x28 mm,
Kettenöffnung 2,3 mm

AN991
79,00 €

matt/polirt,
SW-Perle
Ø ca. 5 mm



Ø ca. 13,5 mm,
Kettenöffnung 2,2 mm

AN1021
69,00 €

matt/polirt,
SW-Perle
Ø ca. 6 mm



Ø ca. 20 mm,
Kettenöffnung 3,7 mm

AN1023
79,00 €

matt/polirt,
SW-Perle
Ø ca. 4 mm



ca. 6x14 mm,
Kettenöffnung 2,1 mm

AN1003
65,00 €

matt,
teilweise
Gelbgold
beschichtet,
SW-Perle
Ø ca. 8 mm



ca. 17x29 mm,
Kettenöffnung 6 mm

AN135
148,50 €

matt/polirt,
Gelbgold
beschichtet,
SW-Perle
Ø ca. 5 mm



Ø ca. 13,5 mm,
Kettenöffnung 2,2 mm

AN1022
85,00 €

matt/polirt,
Gelbgold
beschichtet,
SW-Perle
Ø ca. 6 mm



Ø ca. 20 mm,
Kettenöffnung 3,7 mm

AN1024
99,00 €

geschliffen/
polirt,
Gelbgold
beschichtet,
SW-Button-Perle
Ø ca. 8 mm



H: ca. 17 mm,
Kettenöffnung 3,8 mm

AN421
69,00 €

geschliffen/
polirt,
Gelbgold
beschichtet,
SW-Button-Perle
Ø ca. 10 mm



H: ca. 20 mm,
Kettenöffnung 4,7 mm

AN424
97,50 €

matt/polirt,
Gelbgold
beschichtet,
SW-Perle
Ø ca. 4 mm



ca. 6x14 mm,
Kettenöffnung 2,1 mm

AN1004
79,00 €

matt/polirt/
gekratzt,
Gelbgold
beschichtet,
SW-Perle
Ø ca. 5 mm



Ø ca. 17 mm,
Kettenöffnung 2,1 mm

AN951
85,00 €

matt/polirt/
gekratzt,
Gelbgold
beschichtet,
SW-Perle
Ø ca. 7 mm



Ø ca. 26 mm,
Kettenöffnung 3,5 mm

AN953
99,00 €

matt/polirt/
gekratzt,
Gelbgold
beschichtet,
SW-Perle
Ø ca. 7 mm



Ø ca. 26 mm,
Kettenöffnung 3,5 mm

AN955
165,00 €

geschliffen/
polirt,
Roségold
beschichtet,
SW-Button-Perle
Ø ca. 8 mm



H: ca. 17 mm,
Kettenöffnung 3,8 mm

AN422
69,00 €

geschliffen/
polirt,
Roségold
beschichtet,
SW-Button-Perle
Ø ca. 10 mm



H: ca. 20 mm,
Kettenöffnung 4,7 mm

AN425
97,50 €

polirt,
Zirkonia white



ca. 6x10 mm,
Kettenöffnung 3,6 mm

AN1031
39,00 €

polirt, Gelbgold
beschichtet,
Zirkonia white



ca. 6x10 mm,
Kettenöffnung 3,6 mm

AN1032
49,00 €

matt/polirt,
facettierter
Hämatit



Ø ca. 19 mm,
Kettenöffnung 2,9 mm

AN1005
64,00 €

matt/polirt,
facettierter
Hämatit



Ø ca. 30 mm,
Kettenöffnung 2,9 mm

AN1007
69,00 €

matt/polirt,
facettierter
Hämatit,
Spiegelankerkette
Ø 1,5 mm



L: ca. 7,4 cm
(Hämatit ca. 3 cm),
Kettenöffnung
ca. 3,8 mm

AN1013
53,00 €

matt/polirt,
facettierter
Granat



Ø ca. 19 mm,
Kettenöffnung 2,9 mm

AN1009
64,00 €

matt/polirt,
facettierter
Granat



Ø ca. 30 mm,
Kettenöffnung 2,9 mm

AN1011
69,00 €

matt/polirt,
facettierter
Granat,
Spiegelankerkette
Ø 1,5 mm



L: ca. 7,4 cm
(Granat ca. 3 cm),
Kettenöffnung
ca. 3,8 mm

AN1015
53,00 €

matt/polirt,
Gelbgold
beschichtet,
facettierter
Hämatit



Ø ca. 19 mm,
Kettenöffnung 2,9 mm

AN1006
79,00 €

matt/polirt,
Gelbgold
beschichtet,
facettierter
Hämatit



Ø ca. 30 mm,
Kettenöffnung 2,9 mm

AN1008
89,00 €

matt/polirt,
Gelbgold
beschichtet,
facettierter
Hämatit,
Spiegelankerkette
Ø 1,5 mm

L: ca. 7,4 cm
(Hämatit ca. 3 cm),
Kettenöffnung
ca. 3,8 mm

AN1014
63,00 €



matt/polirt,
Gelbgold
beschichtet,
facettierter
Granat

Ø ca. 19 mm,
Kettenöffnung 2,9 mm

AN1010
79,00 €



matt/polirt,
Gelbgold
beschichtet,
facettierter
Granat

Ø ca. 30 mm,
Kettenöffnung 2,9 mm

AN1012
89,00 €



matt/polirt,
Gelbgold
beschichtet,
facettierter
Granat,
Spiegelankerkette
Ø 1,5 mm

L: ca. 7,4 cm
(Granat ca. 3 cm),
Kettenöffnung
ca. 3,8 mm

AN1016
63,00 €



matt/polirt/
gekratzt

ca. 19x22 mm,
Kettenöffnung 2,3 mm

AN878
76,00 €



matt/polirt/
gekratzt

ca. 44x54 mm,
Kettenöffnung 2,3 mm

AN881
104,00 €



matt/gekratzt/polirt

ca. 9x13 mm,
Kettenöffnung 2,8 mm

AN276
45,00 €



matt/gekratzt/polirt

ca. 14x21 mm,
Kettenöffnung 3 mm

AN270
47,00 €



matt/gekratzt/
polirt

ca. 20x30 mm,
Kettenöffnung 3,5 mm

AN205
49,00 €



matt/gekratzt/
polirt

ca. 37x54 mm,
Kettenöffnung 6 mm

AN211
65,00 €



matt/
gekratzt/
polirt, Brill.
TW/SI 0,016 ct.

ca. 9x13 mm,
Kettenöffnung 2,8 mm

AN279
116,00 €



matt/
gekratzt/
polirt, Brill.
TW/SI 0,016 ct.

ca. 14x21 mm,
Kettenöffnung 3 mm

AN273
119,00 €



matt/gekratzt/
polirt, Brill.
TW/SI 0,02 ct.

ca. 20x30 mm,
Kettenöffnung 3,5 mm

AN226
149,00 €



matt/gekratzt/
polirt,
Brill. TW/SI
0,065 ct.

ca. 37x54 mm,
Kettenöffnung 6 mm

AN229
299,00 €



matt/gekratzt/
polirt, SW-
Button-Perle
Ø ca. 6 mm

ca. 20x30 mm,
Kettenöffnung 3,5 mm

AN208
65,00 €



matt/gekratzt/
polirt, SW-
Button-Perle
Ø ca. 8 mm

ca. 37x54 mm,
Kettenöffnung 6 mm

AN214
85,00 €



matt/polirt/
gekratzt,
teilweise
Gelbgold
beschichtet

ca. 19x22 mm,
Kettenöffnung 2,3 mm

AN879
86,50 €



matt/polirt/
gekratzt,
teilweise
Gelbgold
beschichtet

ca. 44x54 mm,
Kettenöffnung 2,3 mm

AN882
126,00 €



matt/gekratzt/polirt,
teilweise Gelbgold
beschichtet

ca. 9x13 mm,
Kettenöffnung 2,8 mm

AN277
62,00 €



matt/
gekratzt/
polirt, teilweise
Gelbgold
beschichtet

ca. 14x21 mm,
Kettenöffnung 3 mm

AN271
65,00 €



matt/gekratzt/
polirt, teilweise
Gelbgold
beschichtet

ca. 20x30 mm,
Kettenöffnung 3,5 mm

AN206
69,00 €



matt/gekratzt/
polirt,
teilweise
Gelbgold
beschichtet

ca. 37x54 mm,
Kettenöffnung 6 mm

AN212
99,00 €



matt/
gekratzt/
polirt, teilweise
Gelbgold
beschichtet, Brill.
TW/SI 0,016 ct.

ca. 9x13 mm,
Kettenöffnung 2,8 mm

AN280
133,00 €



matt/
gekratzt/
polirt, teilweise
Gelbgold
beschichtet, Brill.
TW/SI 0,016 ct.

ca. 14x21 mm,
Kettenöffnung 3 mm

AN274
137,00 €



matt/gekratzt/
poliert, teilweise
Gelbgold
beschichtet, Brill.
TW/SI 0,02 ct.



ca. 20x30 mm,
Kettenöffnung 3,5 mm

AN227
169,00 €

matt/gekratzt/
poliert, teilweise
Gelbgold
beschichtet,
Brill. TW/SI
0,065 ct.



ca. 37x54 mm,
Kettenöffnung 6 mm

AN230
333,00 €

matt/gekratzt/
poliert, teilweise
Gelbgold
beschichtet,
SW-Button-Perle
Ø ca. 6 mm



ca. 20x30 mm,
Kettenöffnung 3,5 mm

AN209
85,00 €

matt/gekratzt/
poliert, teilweise
Gelbgold
beschichtet,
SW-Button-
Perle Ø ca.
8 mm



ca. 37x54 mm,
Kettenöffnung 6 mm

AN215
119,00 €

matt/polirt/
gekratzt,
teilweise
Roségold
beschichtet



ca. 19x22 mm,
Kettenöffnung 2,3 mm

AN880
86,50 €

matt/polirt/
gekratzt,
teilweise
Roségold
beschichtet



ca. 44x54 mm,
Kettenöffnung 2,3 mm

AN883
126,00 €

matt/gekratzt/polirt,
teilweise Roségold
beschichtet



ca. 9x13 mm,
Kettenöffnung 2,8 mm

AN278
62,00 €

matt/gekratzt/polirt,
teilweise Roségold
beschichtet



ca. 14x21 mm,
Kettenöffnung 3 mm

AN272
65,00 €

matt/
gekratzt/
poliert, teilweise
Roségold
beschichtet



ca. 20x30 mm,
Kettenöffnung 3,5 mm

AN207
69,00 €

matt/gekratzt/
poliert, teilweise
Roségold
beschichtet



ca. 37x54 mm,
Kettenöffnung 6 mm

AN213
99,00 €

matt/
gekratzt/
poliert, teilweise
Roségold
beschichtet, Brill.
TW/SI 0,016 ct.



ca. 9x13 mm,
Kettenöffnung 2,8 mm

AN281
133,00 €

matt/
gekratzt/
poliert, teilweise
Roségold
beschichtet, Brill.
TW/SI 0,016 ct.



ca. 14x21 mm,
Kettenöffnung 3 mm

AN275
137,00 €

matt/gekratzt/
poliert, teilweise
Roségold
beschichtet, Brill.
TW/SI 0,02 ct.



ca. 20x30 mm,
Kettenöffnung 3,5 mm

AN228
169,00 €

matt/gekratzt/
poliert, teilweise
Roségold
beschichtet,
Brill. TW/SI
0,065 ct.



ca. 37x54 mm,
Kettenöffnung 6 mm

AN231
333,00 €

matt/gekratzt/
poliert, teilweise
Roségold
beschichtet,
SW-Button-Perle
Ø ca. 6 mm



ca. 20x30 mm,
Kettenöffnung 3,5 mm

AN210
85,00 €

matt/gekratzt/
poliert, teilweise
Roségold
beschichtet,
SW-Button-
Perle Ø ca.
8 mm



ca. 37x54 mm,
Kettenöffnung 6 mm

AN216
119,00 €

matt/
gekratzt/
poliert, teilweise
Schwarz
beschichtet



ca. 9x13 mm,
Kettenöffnung 2,8 mm

AN417
62,00 €

matt/
gekratzt/
poliert, teilweise
Schwarz
beschichtet



ca. 14x21 mm,
Kettenöffnung 3 mm

AN413
65,00 €

matt/
gekratzt/
poliert, teilweise
Schwarz
beschichtet



ca. 20x30 mm,
Kettenöffnung 3,5 mm

AN407
69,00 €

matt/gekratzt/
poliert,
teilweise
Schwarz
beschichtet



ca. 37x54 mm,
Kettenöffnung 6 mm

AN401
99,00 €

matt/
gekratzt/
poliert, teilweise
Schwarz
beschichtet,
Brill. TW/SI
0,016 ct.



ca. 14x21 mm,
Kettenöffnung 3 mm

AN415
137,00 €

matt/gekratzt



ca. 13x13 mm,
Kettenöffnung 2 mm

AN487
28,00 €

matt/gekratzt



ca. 9x13 mm,
Kettenöffnung 2 mm

AN490
28,00 €

matt/gekratzt



ca. 11x12 mm,
Kettenöffnung 2 mm

AN508
28,00 €

matt/gekratzt



ca. 13x13 mm,
Kettenöffnung 2 mm

AN514
28,00 €

geschliffen



Ø ca. 8 mm,
Kettenöffnung 2 mm

AN493
28,00 €

poliert/gekratzt



Ø ca. 20 mm,
Kettenöffnung 2,9 mm

AN957
48,00 €

poliert/gekratzt



Ø ca. 24 mm,
Kettenöffnung 2,9 mm

AN963
89,00 €

poliert/gekratzt/
matt



Ø ca. 17 mm,
Kettenöffnung 2,1 mm

AN972
55,00 €

poliert/gekratzt/
matt



Ø ca. 25 mm,
Kettenöffnung 2,1 mm

AN974
59,00 €

matt/polirt



ca. 3,5x25 mm,
Kettenöffnung
ca. 2,5 mm

AN1035
32,00 €

poliert, Zirkonia
white



Ø ca. 11 mm,
Kettenöffnung 2,8 mm

AN544.WH
43,50 €

poliert, Zirkonia
white



Ø ca. 11 mm,
Kettenöffnung 2,8 mm

AN547.WH
56,00 €

matt/polirt,
Zirkonia white



ca. 7x12 mm,
Kettenöffnung 5,5 mm

AN910
95,00 €

matt/polirt,
Zirkonia white



ca. 5x12 mm,
Kettenöffnung 5,5 mm

AN916
85,50 €

matt/polirt,
Zirkonia white



ca. 8x12 mm,
Kettenöffnung 5,5 mm

AN922
116,50 €

matt/polirt,
Zirkonia white



ca. 11x12 mm,
Kettenöffnung 5,5 mm

AN919
130,00 €

matt/polirt,
Zirkonia white



ca. 7x12 mm,
Kettenöffnung 5,5 mm

AN913
69,00 €

poliert,
Zirkonia white



ca. 6x12 mm,
Kettenöffnung 5,5 mm

AN925
95,00 €

poliert,
Zirkonia white



ca. 6x12 mm,
Kettenöffnung 5,5 mm

AN928
95,00 €

poliert/gekratzt/
matt, Zirkonia
white



Ø ca. 17 mm,
Kettenöffnung 2,1 mm

AN976
55,00 €

poliert/gekratzt/
matt, Zirkonia
white



Ø ca. 25 mm,
Kettenöffnung 2,1 mm

AN978
59,00 €

poliert,
Zirkonia white



ca. 2x24 mm,
Kettenöffnung 2,4 mm

AN931
46,50 €

poliert,
Zirkonia white
teilausgefasst



Ø ca. 35 mm,
Kettenöffnung 2,8 mm

AN966
85,00 €

poliert,
Zirkonia white
teilausgefasst



Ø ca. 49 mm,
Kettenöffnung 3,6 mm

AN969
99,00 €

<p>matt/polieret, Zirkonia white</p>  <p><i>evia</i></p> <p>ca. 3,5x25 mm, Kettenöffnung ca. 2,5 mm</p> <p>AN1037 45,00 €</p>	<p>poliert, Crystal White Pearl</p>  <p>Ø ca. 12 mm, Kettenöffnung 2 mm</p> <p>AN496.WHP 28,00 €</p>	<p>poliert/gekratzt, SW-Perle Ø ca. 5 mm</p>  <p>Ø ca. 20 mm, Kettenöffnung 2,9 mm</p> <p>AN960 75,00 €</p>	<p>matt/gekratzt, Gelbgold beschichtet</p>  <p>ca. 13x13 mm, Kettenöffnung 2 mm</p> <p>AN488 35,00 €</p>
<p>matt/gekratzt, Gelbgold beschichtet</p>  <p>ca. 9x13 mm, Kettenöffnung 2 mm</p> <p>AN491 35,00 €</p>	<p>matt/gekratzt, Gelbgold beschichtet</p>  <p>ca. 11x12 mm, Kettenöffnung 2 mm</p> <p>AN509 35,00 €</p>	<p>matt/gekratzt, Gelbgold beschichtet</p>  <p>ca. 13x13 mm, Kettenöffnung 2 mm</p> <p>AN515 35,00 €</p>	<p>geschliffen, Gelbgold beschichtet</p>  <p>Ø ca. 8 mm, Kettenöffnung 2 mm</p> <p>AN494 35,00 €</p>
<p>poliert/gekratzt, Gelbgold beschichtet</p>  <p>Ø ca. 20 mm, Kettenöffnung 2,9 mm</p> <p>AN958 65,00 €</p>	<p>poliert/gekratzt, teilweise Gelbgold beschichtet</p>  <p>Ø ca. 24 mm, Kettenöffnung 2,9 mm</p> <p>AN964 105,00 €</p>	<p>poliert/gekratzt/ matt, Gelbgold beschichtet</p>  <p>Ø ca. 17 mm, Kettenöffnung 2,1 mm</p> <p>AN973 69,00 €</p>	<p>poliert/gekratzt/ matt, Gelbgold beschichtet</p>  <p>Ø ca. 25 mm, Kettenöffnung 2,1 mm</p> <p>AN975 75,00 €</p>
<p>matt/polieret, Gelbgold beschichtet</p>  <p>ca. 3,5x25 mm, Kettenöffnung ca. 2,5 mm</p> <p>AN1036 45,00 €</p>	<p>poliert, Gelbgold beschichtet, Zirkonia white</p>  <p>Ø ca. 11 mm, Kettenöffnung 2,8 mm</p> <p>AN545.WH 53,50 €</p>	<p>poliert, Gelbgold beschichtet, Zirkonia white</p>  <p>Ø ca. 11 mm, Kettenöffnung 2,8 mm</p> <p>AN548.WH 66,00 €</p>	<p>matt/polieret, Gelbgold beschichtet, Zirkonia white</p>  <p>ca. 7x12 mm, Kettenöffnung 5,5 mm</p> <p>AN911 120,50 €</p>
<p>matt/polieret, Gelbgold beschichtet, Zirkonia white</p>  <p>ca. 5x12 mm, Kettenöffnung 5,5 mm</p> <p>AN917 97,50 €</p>	<p>matt/polieret, Gelbgold beschichtet, Zirkonia white</p>  <p>ca. 8x12 mm, Kettenöffnung 5,5 mm</p> <p>AN923 130,00 €</p>	<p>matt/polieret, Gelbgold beschichtet, Zirkonia white</p>  <p>ca. 11x12 mm, Kettenöffnung 5,5 mm</p> <p>AN920 137,00 €</p>	<p>matt/polieret, Gelbgold beschichtet, Zirkonia white</p>  <p>ca. 7x12 mm, Kettenöffnung 5,5 mm</p> <p>AN914 78,50 €</p>
<p>poliert, Gelbgold beschichtet, Zirkonia white</p>  <p>ca. 6x12 mm, Kettenöffnung 5,5 mm</p> <p>AN926 120,50 €</p>	<p>poliert, Gelbgold beschichtet, Zirkonia white</p>  <p>ca. 6x12 mm, Kettenöffnung 5,5 mm</p> <p>AN929 120,50 €</p>	<p>poliert, Gelbgold beschichtet, Zirkonia white</p>  <p>ca. 2x24 mm, Kettenöffnung 2,4 mm</p> <p>AN932 59,00 €</p>	<p>poliert/gekratzt/ matt, Gelbgold beschichtet, Zirkonia white</p>  <p>Ø ca. 17 mm, Kettenöffnung 2,1 mm</p> <p>AN977 69,00 €</p>

poliert/gekratzt/
matt, Gelbgold
beschichtet,
Zirkonia
white



Ø ca. 25 mm,
Kettenöffnung 2,1 mm

AN979
75,00 €

poliert, Gelbgold
beschichtet,
Zirkonia white
teilausgefasst



Ø ca. 35 mm,
Kettenöffnung 2,8 mm

AN967
99,00 €

poliert, Gelbgold
beschichtet,
Zirkonia white
teilausgefasst



Ø ca. 49 mm,
Kettenöffnung 3,6 mm

AN970
115,00 €

matt/polirt,
Gelbgold
beschichtet,
Zirkonia white



ca. 3,5x25 mm,
Kettenöffnung
ca. 2,5 mm

AN1038
59,00 €

poliert, Gelbgold
beschichtet, Crystal
White Pearl



Ø ca. 12 mm,
Kettenöffnung 2 mm

AN540.WHP
35,00 €

poliert/gekratzt,
Gelbgold beschichtet,
SW-Perle Ø
ca. 5 mm



Ø ca. 20 mm,
Kettenöffnung 2,9 mm

AN961
89,00 €

matt/gekratzt,
Roségold beschichtet



ca. 13x13 mm,
Kettenöffnung 2 mm

AN489
35,00 €

matt/gekratzt,
Roségold beschichtet



ca. 9x13 mm,
Kettenöffnung 2 mm

AN492
35,00 €

matt/gekratzt,
Roségold beschichtet



ca. 11x12 mm,
Kettenöffnung 2 mm

AN510
35,00 €

matt/gekratzt,
Roségold beschichtet



ca. 13x13 mm,
Kettenöffnung 2 mm

AN516
35,00 €

geschliffen,
Roségold beschichtet



Ø ca. 8 mm,
Kettenöffnung 2 mm

AN495
35,00 €

poliert/gekratzt,
Roségold beschichtet



Ø ca. 20 mm,
Kettenöffnung 2,9 mm

AN959
65,00 €

poliert/gekratzt,
teilweise Roségold
beschichtet



Ø ca. 24 mm,
Kettenöffnung 2,9 mm

AN965
105,00 €

poliert, Roségold
beschichtet,
Zirkonia white



Ø ca. 11 mm,
Kettenöffnung 2,8 mm

AN546.WH
53,50 €

poliert, Roségold
beschichtet,
Zirkonia white



Ø ca. 11 mm,
Kettenöffnung 2,8 mm

AN549.WH
66,00 €

matt/polirt,
Roségold
beschichtet,
Zirkonia white



ca. 7x12 mm,
Kettenöffnung 5,5 mm

AN912
120,50 €

matt/polirt,
Roségold
beschichtet,
Zirkonia white



ca. 5x12 mm,
Kettenöffnung 5,5 mm

AN918
97,50 €

matt/polirt,
Roségold
beschichtet,
Zirkonia white



ca. 8x12 mm,
Kettenöffnung 5,5 mm

AN924
130,00 €

matt/polirt,
Roségold
beschichtet,
Zirkonia white



ca. 11x12 mm,
Kettenöffnung 5,5 mm

AN921
137,00 €

matt/polirt,
Roségold
beschichtet,
Zirkonia white



ca. 7x12 mm,
Kettenöffnung 5,5 mm

AN915
78,50 €

poliert,
Roségold
beschichtet,
Zirkonia white



ca. 6x12 mm,
Kettenöffnung 5,5 mm

AN927
120,50 €

poliert,
Roségold
beschichtet,
Zirkonia white



ca. 6x12 mm,
Kettenöffnung 5,5 mm





AN930
120,50 €

















poliert,
Roségold
beschichtet,
Zirkonia white



























ca. 2x24 mm,
Kettenöffnung 2,4 mm

AN933
59,00 €

<p>poliert, Roségold beschichtet, Zirkonia white teilausgefasst</p>  <p>Ø ca. 35 mm, Kettenöffnung 2,8 mm</p> <p>AN968 99,00 €</p>	<p>poliert, Roségold beschichtet, Zirkonia white teilausgefasst</p>  <p>Ø ca. 49 mm, Kettenöffnung 3,6 mm</p> <p>AN971 115,00 €</p>	<p>poliert, Roségold beschichtet, Crystal White Pearl</p>  <p>Ø ca. 12 mm, Kettenöffnung 2 mm</p> <p>AN541.WHP 35,00 €</p>	<p>poliert/gekratzt, Roségold beschichtet, SW-Perle Ø ca. 5 mm</p>  <p>Ø ca. 20 mm, Kettenöffnung 2,9 mm</p> <p>AN962 89,00 €</p>
<p>matt/gekratzt</p>  <p>ca. 10x21 mm, Kettenöffnung 2 mm</p> <p>AN870 45,00 €</p>	<p>matt/gekratzt</p>  <p>ca. 10x30 mm, Kettenöffnung 2 mm</p> <p>AN873 48,00 €</p>	<p>matt/gekratzt</p>  <p>Ø 6 mm, Kettenöffnung 2 mm</p> <p>AN815 26,50 €</p>	<p>matt/gekratzt</p>  <p>Ø 8 mm, Kettenöffnung 2 mm</p> <p>AN818 28,00 €</p>
<p>matt/polier/gekratzt</p>  <p>ca. 5x26 mm, Kettenöffnung 2 mm</p> <p>AN862 38,00 €</p>	<p>matt/polier, Zirkonia white</p>  <p>Ø ca. 6 mm, Kettenöffnung 2 mm</p> <p>AN809.WH 26,50 €</p>	<p>matt/polier, Zirkonia white</p>  <p>Ø ca. 7 mm, Kettenöffnung 2 mm</p> <p>AN812.WH 28,00 €</p>	<p>poliert, Zirkonia white</p>  <p>Ø ca. 5 mm, Kettenöffnung 2 mm</p> <p>AN800.WH 41,00 €</p>
<p>poliert, Zirkonia white</p>  <p>Ø ca. 9 mm, Kettenöffnung 2 mm</p> <p>AN806.WH 53,50 €</p>	<p>poliert, Zirkonia white</p>  <p>Ø ca. 9 mm, Kettenöffnung 2 mm</p> <p>AN803.WH 43,50 €</p>	<p>matt/polier, SW-Button-Perle Ø ca. 5 mm</p>  <p>Ø ca. 7 mm, Kettenöffnung 2 mm</p> <p>AN833 26,50 €</p>	<p>matt/polier, SW-Button-Perle Ø ca. 6 mm</p>  <p>Ø ca. 9 mm, Kettenöffnung 2 mm</p> <p>AN836 28,00 €</p>
<p>matt/gekratzt, Gelbgold beschichtet</p>  <p>ca. 10x21 mm, Kettenöffnung 2 mm</p> <p>AN871 57,50 €</p>	<p>matt/gekratzt, Gelbgold beschichtet</p>  <p>ca. 10x30 mm, Kettenöffnung 2 mm</p> <p>AN874 60,50 €</p>	<p>matt/gekratzt, Gelbgold beschichtet</p>  <p>Ø ca. 6 mm, Kettenöffnung 2 mm</p> <p>AN816 35,00 €</p>	<p>matt/gekratzt, Gelbgold beschichtet</p>  <p>Ø ca. 8 mm, Kettenöffnung 2 mm</p> <p>AN819 36,50 €</p>
<p>matt/polier/gekratzt, Gelbgold beschichtet</p>  <p>ca. 5x26 mm, Kettenöffnung 2 mm</p> <p>AN863 45,00 €</p>	<p>matt/polier, Zirkonia white, Gelbgold beschichtet</p>  <p>Ø ca. 6 mm, Kettenöffnung 2 mm</p> <p>AN810.WH 35,00 €</p>	<p>matt/polier, Zirkonia white, Gelbgold beschichtet</p>  <p>Ø ca. 7 mm, Kettenöffnung 2 mm</p> <p>AN813.WH 36,50 €</p>	<p>poliert, Zirkonia white, Gelbgold beschichtet</p>  <p>Ø ca. 5 mm, Kettenöffnung 2 mm</p> <p>AN801.WH 48,00 €</p>

<p>poliert, Zirkonia white, Gelbgold beschichtet</p>  <p>Ø ca. 9 mm, Kettenöffnung 2 mm</p> <p>AN807.WH 60,50 €</p>	<p>poliert, Zirkonia white, Gelbgold beschichtet</p>  <p>Ø ca. 9 mm, Kettenöffnung 2 mm</p> <p>AN804.WH 50,50 €</p>	<p>matt/polier, Gelbgold beschichtet, SW-Button-Perle Ø ca. 5 mm</p>  <p>Ø ca. 7 mm, Kettenöffnung 2 mm</p> <p>AN834 35,00 €</p>	<p>matt/polier, Gelbgold beschichtet, SW-Button-Perle Ø ca. 6 mm</p>  <p>Ø ca. 9 mm, Kettenöffnung 2 mm</p> <p>AN837 36,50 €</p>
<p>matt/gekratzt, Roségold beschichtet</p>  <p>ca. 10x21 mm, Kettenöffnung 2 mm</p> <p>AN872 57,50 €</p>	<p>matt/gekratzt, Roségold beschichtet</p>  <p>ca. 10x30 mm, Kettenöffnung 2 mm</p> <p>AN875 60,50 €</p>	<p>matt/gekratzt, Roségold beschichtet</p>  <p>Ø ca. 6 mm, Kettenöffnung 2 mm</p> <p>AN817 35,00 €</p>	<p>matt/gekratzt, Roségold beschichtet</p>  <p>Ø ca. 8 mm, Kettenöffnung 2 mm</p> <p>AN820 36,50 €</p>
<p>matt/polier/gekratzt, Roségold beschichtet</p>  <p>ca. 5x26 mm, Kettenöffnung 2 mm</p> <p>AN864 45,00 €</p>	<p>matt/polier, Roségold beschichtet, Zirkonia white</p>  <p>Ø ca. 6 mm, Kettenöffnung 2 mm</p> <p>AN811.WH 35,00 €</p>	<p>matt/polier, Roségold beschichtet, Zirkonia white</p>  <p>Ø ca. 7 mm, Kettenöffnung 2 mm</p> <p>AN814.WH 36,50 €</p>	<p>poliert, Roségold beschichtet, Zirkonia white</p>  <p>Ø ca. 5 mm, Kettenöffnung 2 mm</p> <p>AN802.WH 48,00 €</p>
<p>poliert, Roségold beschichtet, Zirkonia white</p>  <p>Ø ca. 9 mm, Kettenöffnung 2 mm</p> <p>AN808.WH 60,50 €</p>	<p>poliert, Roségold beschichtet, Zirkonia white</p>  <p>Ø ca. 9 mm, Kettenöffnung 2 mm</p> <p>AN805.WH 50,50 €</p>	<p>matt/polier, Roségold beschichtet, SW-Button-Perle Ø ca. 5 mm</p>  <p>Ø ca. 7 mm, Kettenöffnung 2 mm</p> <p>AN835 35,00 €</p>	<p>matt/polier, Roségold beschichtet, SW-Button-Perle Ø ca. 6 mm</p>  <p>Ø ca. 9 mm, Kettenöffnung 2 mm</p> <p>AN838 36,50 €</p>



<p>matt</p>  <p>B: ca. 16 mm, Wechselschließe für Magnetverschluss groß mit Gewinde</p> <p>AN237 35,00 €</p>	<p>matt</p>  <p>B: ca. 16 mm, Wechselschließe für Magnetverschluss groß mit Gewinde</p> <p>AN232 43,50 €</p>	<p>matt/poliert</p>  <p>B: ca. 16 mm, Wechselschließe für Magnetverschluss groß mit Gewinde</p> <p>AN165 43,50 €</p>	<p>geschliffen/ poliert</p>  <p>B: ca. 16 mm, Wechselschließe für Magnetverschluss groß mit Gewinde</p> <p>AN455 43,50 €</p>
<p>matt/Kautschuk</p>  <p>B: ca. 16 mm, Wechselschließe für Magnetverschluss groß mit Gewinde</p> <p>AN179 49,00 €</p>	<p>matt, Zirkonia white</p>  <p>B: ca. 16 mm, Wechselschließe für Magnetverschluss groß mit Gewinde</p> <p>AN233.WH 95,00 €</p>	<p>matt, Zirkonia black</p>  <p>B: ca. 16 mm, Wechselschließe für Magnetverschluss groß mit Gewinde</p> <p>AN233.BL 95,00 €</p>	<p>matt, Zirkonia white</p>  <p>B: ca. 16 mm, Wechselschließe für Magnetverschluss groß mit Gewinde</p> <p>AN234.WH 69,00 €</p>
<p>matt, Zirkonia black</p>  <p>B: ca. 16 mm, Wechselschließe für Magnetverschluss groß mit Gewinde</p> <p>AN234.BL 69,00 €</p>	<p>matt/poliert, Zirkonia white</p>  <p>B: ca. 16 mm, Wechselschließe für Magnetverschluss groß mit Gewinde</p> <p>AN254 82,50 €</p>	<p>poliert, Zirkonia white</p>  <p>B: ca. 16 mm, Wechselschließe für Magnetverschluss groß mit Gewinde</p> <p>AN537.WH 73,00 €</p>	<p>poliert, Zirkonia black</p>  <p>B: ca. 16 mm, Wechselschließe für Magnetverschluss groß mit Gewinde</p> <p>AN537.BL 73,00 €</p>
<p>geschliffen/ poliert, Zirkonia white</p>  <p>B: ca. 16 mm, Wechselschließe für Magnetverschluss groß mit Gewinde</p> <p>AN261 82,50 €</p>	<p>geschliffen, Zirkonia white</p>  <p>B: ca. 16 mm, Wechselschließe für Magnetverschluss groß mit Gewinde</p> <p>AN430.WH 82,50 €</p>	<p>geschliffen, Zirkonia black</p>  <p>B: ca. 16 mm, Wechselschließe für Magnetverschluss groß mit Gewinde</p> <p>AN430.BL 82,50 €</p>	<p>matt, teilweise Gelbgold beschichtet</p>  <p>B: ca. 16 mm, Wechselschließe für Magnetverschluss groß mit Gewinde</p> <p>AN166 56,00 €</p>
<p>matt/poliert, teilweise Gelbgold beschichtet, Zirkonia white</p>  <p>B: ca. 16 mm, Wechselschließe für Magnetverschluss groß mit Gewinde</p> <p>AN250 95,00 €</p>	<p>geschliffen/ poliert, Gelbgold beschichtet</p>  <p>B: ca. 16 mm, Wechselschließe für Magnetverschluss groß mit Gewinde</p> <p>AN456 56,00 €</p>	<p>matt, Gelbgold beschichtet</p>  <p>B: ca. 16 mm, Wechselschließe für Magnetverschluss groß mit Gewinde</p> <p>AN240 66,00 €</p>	<p>matt, Gelbgold beschichtet, Zirkonia white</p>  <p>B: ca. 16 mm, Wechselschließe für Magnetverschluss groß mit Gewinde</p> <p>AN291.WH 116,50 €</p>
<p>matt, Gelbgold beschichtet, Zirkonia white</p>  <p>B: ca. 16 mm, Wechselschließe für Magnetverschluss groß mit Gewinde</p> <p>AN535.WH 78,50 €</p>	<p>geschliffen, Gelbgold beschichtet, Zirkonia white</p>  <p>B: ca. 16 mm, Wechselschließe für Magnetverschluss groß mit Gewinde</p> <p>AN440.WH 95,00 €</p>	<p>matt, teilweise Gelb- und Roségold beschichtet</p>  <p>B: ca. 16 mm, Wechselschließe für Magnetverschluss groß mit Gewinde</p> <p>AN256 70,50 €</p>	<p>matt/poliert, teilweise Roségold beschichtet, Zirkonia white</p>  <p>B: ca. 16 mm, Wechselschließe für Magnetverschluss groß mit Gewinde</p> <p>AN252 95,00 €</p>

geschliffen/
poliert,
Roségold
beschichtet



B: ca. 16 mm,
Wechselschließe für
Magnetverschluss groß
mit Gewinde

AN457
56,00 €

matt, Roségold
beschichtet



B: ca. 16 mm,
Wechselschließe für
Magnetverschluss groß
mit Gewinde

AN241
66,00 €

matt, Roségold
beschichtet,
Zirkonia white



B: ca. 16 mm,
Wechselschließe für
Magnetverschluss groß
mit Gewinde

AN292.WH
116,50 €

matt, Roségold
beschichtet,
Zirkonia white



B: ca. 16 mm,
Wechselschließe für
Magnetverschluss groß
mit Gewinde

AN536.WH
78,50 €

geschliffen,
Roségold
beschichtet,
Zirkonia white



B: ca. 16 mm,
Wechselschließe für
Magnetverschluss groß
mit Gewinde

AN442.WH
95,00 €

geschliffen/poliert,
Schwarz
beschichtet



B: ca. 16 mm,
Wechselschließe für
Magnetverschluss groß
mit Gewinde

AN459
56,00 €

matt, Schwarz
beschichtet



B: ca. 16 mm,
Wechselschließe für
Magnetverschluss groß
mit Gewinde

AN295
66,00 €

matt, Schwarz
beschichtet,
Zirkonia white



B: ca. 16 mm,
Wechselschließe für
Magnetverschluss groß
mit Gewinde

AN296.WH
116,50 €

geschliffen,
Schwarz
beschichtet,
Zirkonia white



B: ca. 16 mm,
Wechselschließe für
Magnetverschluss groß
mit Gewinde

AN446.WH
95,00 €

geschliffen,
Schwarz
beschichtet,
Zirkonia black



B: ca. 16 mm,
Wechselschließe für
Magnetverschluss groß
mit Gewinde

AN446.BL
95,00 €



silk wood braun



AN700
25,00 €

ca. 17x34 mm

silk wood braun



AN340.3
25,00 €

Ø ca. 28 mm

silk wood schwarz



AN701
25,00 €

ca. 17x34 mm

silk wood schwarz



AN702
25,00 €

Ø ca. 28 mm

Wechselschließe
matt/graviert



ca. 12x22 mm,
für Magnetverschluss
flach

AN703
43,50 €

Wechselschließe
matt/graviert



ca. 12x22 mm,
für Magnetverschluss
flach

AN704
43,50 €

Wechselschließe
matt/graviert



ca. 12x22 mm,
für Magnetverschluss
flach

AN705
43,50 €

Wechselschließe
matt/graviert



ca. 12x22 mm,
für Magnetverschluss
flach

AN706
43,50 €

Wechselschließe
matt/graviert



ca. 12x22 mm,
für Magnetverschluss
flach

AN708
43,50 €

Wechselschließe
matt/graviert



ca. 12x22 mm,
für Magnetverschluss
flach

AN709
43,50 €

poliert



B: ca. 14 mm,
Wechselschließe für
Magnetverschluss klein
ohne Gewinde

AN755
32,00 €

matt



B: ca. 14 mm,
Wechselschließe für
Magnetverschluss klein
ohne Gewinde

AN757
32,00 €

matt



B: ca. 14 mm,
Wechselschließe klein
für Magnetverschluss
ohne Gewinde

AN720
30,50 €

matt



B: ca. 14 mm,
Wechselschließe für
Magnetverschluss klein
ohne Gewinde

AN749
43,00 €

matt/poliert



B: ca. 14 mm,
Wechselschließe klein
für Magnetverschluss
ohne Gewinde

AN728
78,50 €

geschliffen



B: ca. 14 mm,
Wechselschließe klein
für Magnetverschluss
ohne Gewinde

AN724
38,00 €

matt/graviert



B: ca. 14 mm,
Wechselschließe für
Magnetverschluss klein
ohne Gewinde























AN752
43,00 €

matt/graviert

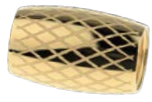

B: ca. 14 mm,
Wechselschließe klein
für Magnetverschluss
ohne Gewinde

AN743
43,50 €

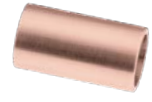
<p>matt/graviert</p>  <p>B: ca. 14 mm, WechselschlieÙe klein für Magnetverschluss ohne Gewinde</p> <p>AN744 43,50 €</p>	<p>matt/graviert</p>  <p>B: ca. 14 mm, WechselschlieÙe klein für Magnetverschluss ohne Gewinde</p> <p>AN745 43,50 €</p>	<p>matt/graviert</p>  <p>B: ca. 14 mm, WechselschlieÙe klein für Magnetverschluss ohne Gewinde</p> <p>AN746 43,50 €</p>	<p>matt/graviert</p>  <p>B: ca. 14 mm, WechselschlieÙe für Magnetverschluss klein ohne Gewinde</p> <p>AN747 43,50 €</p>
<p>antik-matt</p>  <p>B: ca. 14 mm, WechselschlieÙe für Magnetverschluss klein ohne Gewinde</p> <p>AN748 43,50 €</p>	<p>antik-matt</p>  <p>B: ca. 14 mm, WechselschlieÙe für Magnetverschluss klein ohne Gewinde</p> <p>AN750 43,00 €</p>	<p>matt/poliert</p>  <p>B: ca. 14 mm, WechselschlieÙe klein für Magnetverschluss ohne Gewinde</p> <p>AN759 XXX €</p>	<p>matt/poliert, Zirkonia white</p>  <p>B: ca. 14 mm, WechselschlieÙe klein für Magnetverschluss ohne Gewinde</p> <p>AN732.WH 69,00 €</p>
<p>matt, Zirkonia white</p>  <p>B: ca. 14 mm, WechselschlieÙe klein für Magnetverschluss ohne Gewinde</p> <p>AN736.WH 88,00 €</p>	<p>poliert, Zirkonia white</p>  <p>B: ca. 14 mm, WechselschlieÙe klein für Magnetverschluss ohne Gewinde</p> <p>AN740.WH 146,00 €</p>	<p>matt, teilweise Gelbgold beschichtet</p>  <p>B: ca. 14 mm, WechselschlieÙe klein für Magnetverschluss ohne Gewinde</p> <p>AN729 92,00 €</p>	<p>matt/poliert, teilweise Gelbgold beschichtet</p>  <p>B: ca. 14 mm, WechselschlieÙe klein für Magnetverschluss ohne Gewinde</p> <p>AN760 XXX €</p>
<p>matt, Gelbgold beschichtet</p>  <p>B: ca. 14 mm, WechselschlieÙe klein für Magnetverschluss ohne Gewinde</p> <p>AN721 43,50 €</p>	<p>matt, Gelbgold beschichtet</p>  <p>B: ca. 14 mm, WechselschlieÙe für Magnetverschluss klein ohne Gewinde</p> <p>AN751 55,00 €</p>	<p>poliert, Gelbgold beschichtet</p>  <p>B: ca. 14 mm, WechselschlieÙe für Magnetverschluss klein ohne Gewinde</p> <p>AN756 42,00 €</p>	<p>matt, Gelbgold beschichtet</p>  <p>B: ca. 14 mm, WechselschlieÙe für Magnetverschluss klein ohne Gewinde</p> <p>AN758 42,00 €</p>
<p>geschliffen, Gelbgold beschichtet</p>  <p>B: ca. 14 mm, WechselschlieÙe klein für Magnetverschluss ohne Gewinde</p> <p>AN725 49,00 €</p>	<p>poliert, Gelbgold beschichtet</p>  <p>B: ca. 14 mm, WechselschlieÙe für Magnetverschluss klein ohne Gewinde</p> <p>AN753 55,00 €</p>	<p>matt/poliert, Gelbgold beschichtet</p>  <p>B: ca. 14 mm, WechselschlieÙe klein für Magnetverschluss ohne Gewinde</p> <p>AN761 XXX €</p>	<p>poliert, teilweise Gelbgold beschichtet, Zirkonia white</p>  <p>B: ca. 14 mm, WechselschlieÙe klein für Magnetverschluss ohne Gewinde</p> <p>AN741.WH 164,00 €</p>
<p>matt/poliert, teilweise Gelbgold beschichtet, Zirkonia white</p>  <p>B: ca. 14 mm, WechselschlieÙe klein für Magnetverschluss ohne Gewinde</p> <p>AN733.WH 78,50 €</p>	<p>matt, Gelbgold beschichtet, Zirkonia white</p>  <p>B: ca. 14 mm, WechselschlieÙe klein für Magnetverschluss ohne Gewinde</p> <p>AN737.WH 111,00 €</p>	<p>matt, teilweise Roségold beschichtet</p>  <p>B: ca. 14 mm, WechselschlieÙe klein für Magnetverschluss ohne Gewinde</p> <p>AN730 92,00 €</p>	<p>matt, Roségold beschichtet</p>  <p>B: ca. 14 mm, WechselschlieÙe klein für Magnetverschluss ohne Gewinde</p> <p>AN722 43,50 €</p>

geschliffen,
Roségold
beschichtet



B: ca. 14 mm,
WechselschlieÙe klein
für Magnetverschluss
ohne Gewinde

AN726
49,00 €

poliert, Roségold
beschichtet



B: ca. 14 mm,
WechselschlieÙe für
Magnetverschluss klein
ohne Gewinde

AN754
55,00 €

poliert, teilweise
Roségold
beschichtet,
Zirkonia white



B: ca. 14 mm,
WechselschlieÙe klein
für Magnetverschluss
ohne Gewinde

AN742.WH
164,00 €

matt/polirt,
teilweise
Roségold
beschichtet,
Zirkonia white



B: ca. 14 mm,
WechselschlieÙe klein
für Magnetverschluss
ohne Gewinde

AN734.WH
78,50 €

matt, Roségold
beschichtet,
Zirkonia white



B: ca. 14 mm,
WechselschlieÙe klein
für Magnetverschluss
ohne Gewinde

AN738.WH
111,00 €

matt, teilweise
Schwarz
beschichtet



B: ca. 14 mm,
WechselschlieÙe klein
für Magnetverschluss
ohne Gewinde

AN731
92,00 €

matt, Schwarz
beschichtet



B: ca. 14 mm,
WechselschlieÙe klein
für Magnetverschluss
ohne Gewinde

AN723
43,50 €

geschliffen,
Schwarz
beschichtet



B: ca. 14 mm,
WechselschlieÙe klein
für Magnetverschluss
ohne Gewinde

AN727
49,00 €

matt/polirt,
teilweise
Schwarz
beschichtet,
Zirkonia white



B: ca. 14 mm,
WechselschlieÙe klein
für Magnetverschluss
ohne Gewinde

AN735.WH
78,50 €

matt, Schwarz
beschichtet,
Zirkonia white



B: ca. 14 mm,
WechselschlieÙe klein
für Magnetverschluss
ohne Gewinde

AN739.WH
111,00 €

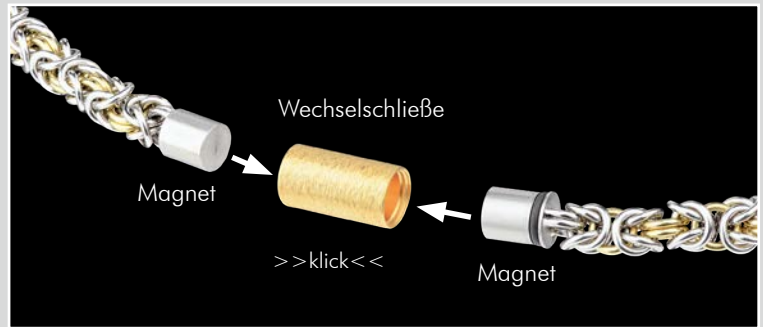

poliert



Magnet-Carrier,
Kettenöffnung
ca. 2,5 mm

AN1040
19,00 €

poliert



EDvita petit

L: ca. 5 cm+Magnet,
für Magnetverschluss
ohne Gewinde

AN1041
45,00 €

poliert, teilweise
Gelbgold
beschichtet



EDvita petit

L: ca. 5 cm+Magnet,
für Magnetverschluss
ohne Gewinde

AN1042
49,00 €

poliert,
facettierter Hämatit



EDvita petit

L: ca. 5 cm+Magnet,
für Magnetverschluss
ohne Gewinde

AN1043
49,00 €

poliert, facettierter
Hämatit, teilweise
Gelbgold
beschichtet



EDvita petit

L: ca. 5 cm+Magnet,
für Magnetverschluss
ohne Gewinde

AN1044
55,00 €

poliert,
facettierter Granat



EDvita petit

L: ca. 5 cm+Magnet,
für Magnetverschluss
ohne Gewinde

AN1045
49,00 €

poliert, facettierter
Granat, teilweise
Gelbgold
beschichtet



EDvita petit

L: ca. 5 cm+Magnet,
für Magnetverschluss
ohne Gewinde

AN1046
55,00 €

poliert,
facettierter Peridot



EDvita petit

L: ca. 5 cm+Magnet,
für Magnetverschluss
ohne Gewinde

AN1047
49,00 €

poliert, facettierter
Peridot, teilweise
Gelbgold
beschichtet



EDvita petit

L: ca. 5 cm+Magnet,
für Magnetverschluss
ohne Gewinde

AN1048
55,00 €

matt/poliert, 2x
Brill. TW/SI 0,02 ct.



ca. 3x11 mm

E568
235,50 €

matt/poliert, 2x
Brill. TW/SI 0,016 ct.



ca. 3x11 mm

E486
178,50 €

poliert, 2x
Brill. TW/SI 0,016 ct.



ca. 3x11 mm

E487
178,50 €

matt/poliert, 2x
Brill. TW/SI 0,016 ct.



ca. 5x12 mm

E488
185,00 €

poliert, 2x
Brill. TW/SI 0,016 ct.



ca. 5x12 mm

E489
185,00 €

matt/poliert, 2x
Brill. TW/SI 0,02 ct.



B: ca. 3 mm,
Ø ca. 13,5 mm

E490
285,00 €

poliert, 2x
Brill. TW/SI 0,02 ct.



B: ca. 3 mm,
Ø ca. 13,5 mm

E491
285,00 €

matt/poliert, 2x
Brill. TW/SI 0,02 ct.



B: ca. 5 mm,
Ø ca. 13,5 mm

E492
294,00 €

poliert, 2x
Brill. TW/SI 0,02 ct.



B: ca. 5 mm,
Ø ca. 13,5 mm

E493
294,00 €

matt, 2x Brill. TW/SI
ca. 0,016 ct.



ca. 4x4 mm

E139
132,50 €

matt/poliert,
2x Brill. TW/SI
0,02 ct.



ca. 1,5x13 mm

E512
233,00 €

matt/poliert,
2x Brill. TW/SI
0,02 ct.



ca. 6x11 mm

E668
239,00 €

matt/poliert,
2x Brill. TW/SI
0,02 ct.



je ca. 7x20 mm

E527
278,50 €

matt/gekratzt,
2x Brill. TW/SI
0,012 ct.



ca. 6x6 mm

E519
155,00 €

matt/poliert,
2x Brill. TW/SI
0,02 ct.



Ø ca. 6 mm

E538
235,50 €

matt/poliert,
2x Brill. TW/SI
0,02 ct.



Ø ca. 7 mm

E534
235,50 €

matt, 2x Brill. TW/SI
0,02 ct.



Ø ca. 4 mm

E535
235,50 €

matt, 2x Brill. TW/SI
0,035 ct.



Ø ca. 5 mm

E536
294,00 €

matt, 2x Brill. TW/SI
0,065 ct.



Ø ca. 6 mm

E537
525,50 €

matt, 2x Brill. TW/SI
ca. 0,016 ct.



ca. 6x6 mm

E140
134,00 €

matt, 2x Brill. TW/SI
ca. 0,016 ct.



Ø ca. 4 mm

E272
187,50 €

matt, 2x Brill. TW/SI
ca. 0,035 ct.



Ø ca. 4 mm

E273
354,00 €

matt, 2x Brill. TW/SI
ca. 0,016 ct.



B: ca. 3 mm,
Ø ca. 12 mm

E113
195,00 €

matt, 2x Brill. TW/SI
ca. 0,016 ct.



B: ca. 3 mm,
Ø ca. 15 mm

E107
198,00 €

matt, 2x Brill. TW/SI
ca. 0,016 ct.



B: ca. 5 mm,
Ø ca. 12 mm

E115
200,50 €

matt, 2x Brill. TW/SI
ca. 0,016 ct.



B: ca. 5 mm,
Ø ca. 15 mm

E109
203,00 €

matt, 2x Brill. TW/SI
ca. 0,016 ct.



B: ca. 7 mm,
Ø ca. 12 mm

E117
204,50 €

matt, 2x Brill. TW/SI
ca. 0,016 ct.



B: ca. 7 mm,
Ø ca. 15 mm

E111
207,00 €

matt/polier/gekratz,
Brill. TW/SI
0,02 ct.



Ø ca. 9,5 mm

E594
278,50 €

matt/polier,
2x Brill.
TW/SI 0,02 ct.,



ca. 6x14 mm

E609
239,00 €

matt/polier/gekratz,
2x Brill.
TW/SI 0,02 ct.,



Ø ca. 12 mm

E612
239,00 €

polier, 2x Brill.
TW/SI 0,02 ct.,



ca. 5x16 mm

E614
235,00 €

matt/polier, 2x Brill.
TW/SI 0,02 ct.



ca. 7x11

E678
239,00 €

matt/gekratz/polier,
2x Brill. TW/SI
0,02 ct.



Ø ca. 10,5 mm

E730
199,00 €

matt/polier,
585er Gelbgold,
2x Brill.
TW/SI 0,016 ct.



Ø 7 mm

E496
244,50 €

matt/polier,
585er Gelbgold,
2x Brill.
TW/SI 0,016 ct.



Ø 10 mm

E498
299,00 €

matt/polier/gekratz,
teilweise Gelbgold
beschichtet,
Brill. TW/SI
0,02 ct.



Ø ca. 9,5 mm

E595
299,00 €

matt/gekratz/polier,
Gelbgold
beschichtet,
2x Brill. TW/SI
0,02 ct.



Ø ca. 10,5 mm

E731
219,00 €

matt/gekratz,
585er Gelbgold,
2x Brill. TW/SI
0,012 ct.



ca. 6x6 mm

E520
235,50 €

matt/gekratz,
585er Roségold,
2x Brill. TW/SI
0,012 ct.



ca. 6x6 mm

E521
235,50 €

matt/polier,
585er Roségold,
2x Brill.
TW/SI 0,016 ct.



Ø 7 mm

E497
244,50 €

matt/polier,
585er Roségold,
2x Brill.
TW/SI 0,016 ct.



Ø 10 mm

E499
299,00 €

matt, Kautschuk,
2x Brill. TW/SI
ca. 0,016 ct.



ca. 6x6 mm

E162
150,00 €

matt, Kautschuk,
2x Brill. TW/SI
ca. 0,016 ct.



ca. 6x6 mm

E158
150,00 €

matt/polier,
teilweise Schwarz
beschichtet,
2x Brill.
TW/SI 0,016 ct.



Ø 7 mm

E494
176,00 €

matt/polier,
teilweise Schwarz
beschichtet,
2x Brill.
TW/SI 0,016 ct.



Ø 10 mm

E495
185,00 €

matt,
585er Gelbgold



H: ca. 9 mm

E75
95,00 €

matt/polier



H: ca. 9 mm

E76
35,00 €

matt

ca. 4x4 mm

E88
25,00 €

matt

ca. 6x6 mm

E89
30,50 €

matt

H: ca. 12 mm

E20.S.O
28,00 €

matt

H: ca. 12 mm

E20.S
29,00 €

matt

B: ca. 3 mm,
Ø ca. 12 mm

E112
74,50 €

matt

B: ca. 3 mm,
Ø ca. 15 mm

E106
77,00 €

matt

B: ca. 5 mm,
Ø ca. 12 mm

E114
78,50 €

matt

B: ca. 5 mm,
Ø ca. 15 mm

E108
82,50 €

matt

B: ca. 7 mm,
Ø ca. 12 mm

E116
84,00 €

matt

B: ca. 7 mm,
Ø ca. 15 mm

E110
86,50 €

matt

Ø ca. 5 mm

E171
30,50 €

matt

Ø ca. 6 mm

E173
35,00 €

matt

Ø ca. 7 mm

E175
38,00 €

matt

ca. 4x4 mm

E84
28,00 €

matt

ca. 6x6 mm

E85
35,00 €

matt, Kautschuk

ca. 6x6 mm

E161
38,00 €

matt, Kautschuk

ca. 6x6 mm

E157
38,00 €

matt/poliert/
gekratzt

ca. 7x13 mm

E522
73,00 €

poliert

ca. 1,5x75 mm

E613
65,00 €

matt/poliert/gekratzt

Ø ca. 9,5 mm

E592
88,00 €

matt

Ø ca. 7 mm

E275
49,00 €

matt

Ø ca. 10 mm

E276
56,00 €

matt/poliert

ca. 2x39 mm

E514
69,00 €

matt/poliert

ca. 2x47 mm

E515
78,50 €

poliert/gekratzt

ca. 11x33 mm

E610
79,00 €

gekratzt/poliert/
matt

ca. 9x24 mm

E674
109,00 €

matt/gekratzt/
poliert

Ø ca. 8 mm

E615
65,00 €

matt/gekratzt/
poliert

Ø ca. 12 mm

E617
69,00 €

matt/poliert

ca. 10x40 mm

E670
85,00 €

poliert/gekratzt/matt

ca. 15x16 mm,
L: ca. 150 mm

E672
111,00 €

matt/poliert/
gekratzt

ca. 20x20 mm

E676
109,00 €

gekratzt/poliert

Ø ca. 9 mm

E724
59,00 €

matt/poliert/gekratzt

Ø ca. 20 mm

E728
119,00 €

matt/poliert/graviert

Ø ca. 8 mm

E502
43,50 €

matt/poliert/graviert

Ø ca. 8 mm

E503
43,50 €

matt/poliert/graviert

Ø ca. 8 mm

E504
43,50 €

matt, teilweise
Gelbgold beschichtet

H: ca. 12 mm

E20.Bi
41,00 €

matt/poliert/gekratzt,
teilweise Gelbgold
beschichtet

Ø ca. 9,5 mm

E593
104,00 €

matt, teilweise
Gelbgold
beschichtet

Ø ca. 7 mm

E277
59,00 €

matt, teilweise
Gelbgold
beschichtet

Ø ca. 10 mm

E278
70,50 €

matt/poliert/
gekratzt, teilweise
Gelbgold
beschichtet

ca. 7x13 mm

E523
88,00 €

matt/poliert,
teilweise
Gelbgold
beschichtet

Ø ca. 19 mm

E566
176,00 €

matt/poliert/
gekratzt, teilweise
Gelbgold
beschichtet

Ø ca. 8 mm

E616
79,00 €

matt/poliert/
gekratzt, teilweise
Gelbgold
beschichtet

Ø ca. 12 mm

E618
95,00 €

matt/gekratzt/poliert,
teilweise Gelbgold
beschichtet

ca. 15x16 mm,
L: ca. 150 mm

E673
135,00 €

gekratzt/matt/
poliert, teilweise
Gelbgold
beschichtet

ca. 9x24 mm

E675
135,00 €

gekratzt/poliert,
teilweise Gelbgold
beschichtet

Ø ca. 9 mm

E725
69,00 €

matt/poliert/gekratzt,
teilweise Gelbgold
beschichtet

Ø ca. 9 mm

E729
135,00 €

poliert/gekratzt,
Gelbgold
beschichtet

E611
109,00 €

ca. 11x33 mm

matt/polieret,
Gelbgold
beschichtet

E671
99,00 €

ca. 10x40 mm

matt/polieret/
gekratzt,
Gelbgold
beschichtet

E677
139,00 €

ca. 20x20 mm

matt/polieret/
gekratzt, teilweise
Roségold
beschichtet

E524
88,00 €

ca. 7x13 mm

matt, teilweise
Roségold
beschichtet

E279
59,00 €

Ø ca. 7 mm

matt, teilweise
Roségold
beschichtet

E280
70,50 €

Ø ca. 10 mm

matt, teilweise
Altbronze
beschichtet

E281
59,00 €

Ø ca. 7 mm

matt, teilweise
Altbronze
beschichtet

E282
70,50 €

Ø ca. 10 mm

matt, teilweise
Schwarz
beschichtet

E283
59,00 €

Ø ca. 7 mm

matt, teilweise
Schwarz
beschichtet

E284
70,50 €

Ø ca. 10 mm

matt/polieret,
2x SW-Button-
Perle Ø ca.
6 mm

E222
69,00 €

Ø ca. 10 mm

matt/polieret,
2x SW-Perle
Ø ca. 4 mm

E250
78,50 €

Ø ca. 8 mm

matt, 2x SW-Perle
Ø ca. 6 mm

E148
73,00 €

L: ca. 21 mm

matt, 2x SW-Perle
Ø ca. 6 mm

E147
76,00 €

L: ca. 32 mm

matt/polieret,
2x SW-Perle
Ø ca. 5 mm

E187
69,00 €

H: ca. 13 mm

matt/polieret,
2x SW-Perle
Ø ca. 4 mm

E208
134,00 €

B: ca. 6 mm,
Ø ca. 13 mm

geschliffen/polieret,
2x SW-Perle
Ø ca. 6 mm

E311
70,50 €

ca. 4x15 mm

matt,
SW-Perlen
Ø 4/5/6 mm

E596
189,00 €

ca. 2x28 mm

matt/polieret,
SW-Perlen
Ø ca. 3 mm

E561
88,00 €

ca. 1,5x13 mm

matt/polieret,
SW-Perlen
Ø ca. 3,5 mm

E562
92,00 €

ca. 1,5x22 mm

matt/polieret/
gekratzt,
SW-Perlen
Ø ca. 4 mm

E619
89,00 €

Ø ca. 12 mm

matt/polieret/
gekratzt,
SW-Perlen
Ø ca. 5 mm























E621
135,00 €

Ø ca. 17 mm

polieret,
SW-Perlen
Ø ca. 6 mm

E669
139,00 €

ca. 7x45 mm

<p>matt/polirt, SW-Perlen Ø ca. 3 mm</p>  <p>ca. 5x10 mm</p> <p>E679 92,00 €</p>	<p>matt/polirt, SW-Perlen Ø ca. 5 mm</p>  <p>Ø ca. 13,5 mm</p> <p>E726 99,00 €</p>	<p>2x SW-Perle Ø ca. 3 mm</p>  <p>E143 20,50 €</p>	<p>2x SW-Perle Ø ca. 4 mm</p>  <p>E144 28,00 €</p>
<p>2x SW-Perle Ø ca. 5 mm</p>  <p>E145 41,00 €</p>	<p>2x SW-Perle Ø ca. 6 mm</p>  <p>E146 53,50 €</p>	<p>2x SW-Perle Ø ca. 7 mm</p>  <p>E247 78,50 €</p>	<p>2x SW-Perle Ø ca. 8 mm</p>  <p>E248 155,00 €</p>
<p>2x SW-Button-Perle Ø ca. 7 mm</p>  <p>E257 35,00 €</p>	<p>2x SW-Button-Perle Ø ca. 8 mm</p>  <p>E258 49,00 €</p>	<p>2x SW-Button-Perle Ø ca. 9 mm</p>  <p>E259 69,00 €</p>	<p>2x SW-Button-Perle Ø ca. 10 mm</p>  <p>E260 88,00 €</p>
<p>matt, teilweise Gelbgold beschichtet, 2x SW-Perle Ø ca. 6 mm</p>  <p>Ø ca. 10 mm</p> <p>E223 82,50 €</p>	<p>matt, teilweise Gelbgold beschichtet, 2x SW- Button-Perle Ø ca. 4 mm</p>  <p>B: ca. 6 mm, Ø ca. 13 mm</p> <p>E209 155,00 €</p>	<p>matt, Gelbgold beschichtet, 2x SW-Perle Ø ca. 6 mm</p>  <p>H: ca. 21 mm</p> <p>E150 88,00 €</p>	<p>matt, Gelbgold beschichtet, 2x SW-Perle Ø ca. 6 mm</p>  <p>H: ca. 32 mm</p> <p>E149 92,00 €</p>
<p>matt/polirt/ gekratzt, Gelbgold beschichtet, SW-Perlen Ø ca. 4 mm</p>  <p>Ø ca. 12 mm</p> <p>E620 109,00 €</p>	<p>matt/polirt/ gekratzt, Gelbgold beschichtet, SW-Perlen Ø ca. 5 mm</p>  <p>Ø ca. 17 mm</p> <p>E622 159,00 €</p>	<p>geschliffen/polirt, Gelbgold beschichtet, 2x SW-Perle Ø ca. 6 mm</p>  <p>ca. 4x15 mm</p> <p>E312 95,00 €</p>	
<p>matt/polirt, Gelbgold beschichtet, SW-Perlen Ø ca. 3 mm</p>  <p>ca. 5x10 mm</p> <p>E680 109,00 €</p>	<p>matt/polirt, Gelbgold beschichtet, SW-Perlen Ø ca. 5 mm</p>  <p>Ø ca. 13,5 mm</p> <p>E727 129,00 €</p>	<p>geschliffen/polirt, Roségold beschichtet, 2x SW-Perle Ø ca. 6 mm</p>  <p>ca. 4x15 mm</p> <p>E313 95,00 €</p>	

matt/polieret,
facettierter
Hämatit



Ø ca. 14 mm

E681
89,00 €

matt/polieret,
facettierter
Hämatit



Ø ca. 12/19 mm,
L: ca. 34 mm

E683
129,00 €

matt/polieret,
facettierter
Hämatit



Ø ca. 30 mm

E685
119,00 €

matt/polieret,
facettierter
Hämatit,
Spiegelankerkette
Ø 1,5 mm



L: ca. 7,8 cm
(Hämatit ca. 3 cm),
Ohrsteckerkopf:
Ø ca. 6 mm

E701
79,00 €

matt/polieret,
facettierter
Granat



Ø ca. 14 mm

E695
89,00 €

matt/polieret,
facettierter
Granat



Ø ca. 12/19 mm,
L: ca. 34 mm

E697
129,00 €

matt/polieret,
facettierter
Granat



Ø ca. 30 mm

E699
119,00 €

matt/polieret,
facettierter
Granat,
Spiegelankerkette
Ø 1,5 mm



L: ca. 7,8 cm
(Granat ca. 3 cm),
Ohrsteckerkopf:
Ø ca. 6 mm

E703
79,00 €

matt/polieret,
Gelbgold
beschichtet,
facettierter
Hämatit



Ø ca. 14 mm

E682
105,00 €

matt/polieret,
Gelbgold
beschichtet,
facettierter
Hämatit



Ø ca. 12/19 mm,
L: ca. 34 mm

E684
159,00 €

matt/polieret,
Gelbgold
beschichtet,
facettierter
Hämatit



Ø ca. 30 mm

E686
149,00 €

matt/polieret,
Gelbgold
beschichtet,
facettierter
Hämatit,
Spiegelankerkette
Ø 1,5 mm



L: ca. 7,8 cm
(Hämatit ca. 3 cm),
Ohrsteckerkopf:
Ø ca. 6 mm

E702
99,00 €

matt/polieret,
Gelbgold
beschichtet,
facettierter
Granat



Ø ca. 14 mm

E696
105,00 €

matt/polieret,
Gelbgold
beschichtet,
facettierter
Granat



Ø ca. 12/19 mm,
L: ca. 34 mm

E698
159,00 €

matt/polieret,
Gelbgold
beschichtet,
facettierter
Granat



Ø ca. 30 mm

E700
149,00 €

























matt/polieret,
Gelbgold
beschichtet,
facettierter
Granat,
Spiegelankerkette
Ø 1,5 mm



















































L: ca. 7,8 cm
(Granat ca. 3 cm),
Ohrsteckerkopf:
Ø ca. 6 mm

E704
99,00 €



<p>matt</p>  <p>Ø ca. 3 mm</p> <p>E183 25,00 €</p>	<p>matt</p>  <p>Ø ca. 4 mm</p> <p>E184 26,00 €</p>	<p>matt</p>  <p>Ø ca. 5 mm</p> <p>E185 27,00 €</p>	<p>matt</p>  <p>Ø ca. 6 mm</p> <p>E186 28,00 €</p>
<p>geschliffen</p>  <p>Ø ca. 3 mm</p> <p>E389 27,00 €</p>	<p>geschliffen</p>  <p>Ø ca. 4 mm</p> <p>E390 28,00 €</p>	<p>geschliffen</p>  <p>Ø ca. 5 mm</p> <p>E391 29,00 €</p>	<p>geschliffen</p>  <p>Ø ca. 6 mm</p> <p>E392 30,00 €</p>
<p>matt</p>  <p>ca. 3x3 mm</p> <p>E409 30,00 €</p>	<p>matt</p>  <p>ca. 4x4 mm</p> <p>E410 31,00 €</p>	<p>matt</p>  <p>ca. 5x5 mm</p> <p>E411 32,00 €</p>	<p>matt</p>  <p>ca. 6x6 mm</p> <p>E412 33,00 €</p>
<p>matt</p>  <p>ca. 3x3 mm</p> <p>E429 30,00 €</p>	<p>matt</p>  <p>ca. 4x4 mm</p> <p>E430 31,00 €</p>	<p>matt</p>  <p>ca. 5x5 mm</p> <p>E431 32,00 €</p>	<p>matt</p>  <p>ca. 6x6 mm</p> <p>E432 33,00 €</p>
<p>matt, teilweise Gelbgold beschichtet</p>  <p>Ø ca. 3 mm</p> <p>E285 32,00 €</p>	<p>matt, teilweise Gelbgold beschichtet</p>  <p>Ø ca. 4 mm</p> <p>E286 33,00 €</p>	<p>matt, teilweise Gelbgold beschichtet</p>  <p>Ø ca. 5 mm</p> <p>E287 34,00 €</p>	<p>matt, teilweise Gelbgold beschichtet</p>  <p>Ø ca. 6 mm</p> <p>E288 35,00 €</p>
<p>geschliffen, teilweise Gelbgold beschichtet</p>  <p>Ø ca. 3 mm</p> <p>E393 34,00 €</p>	<p>geschliffen, teilweise Gelbgold beschichtet</p>  <p>Ø ca. 4 mm</p> <p>E394 35,00 €</p>	<p>geschliffen, teilweise Gelbgold beschichtet</p>  <p>Ø ca. 5 mm</p> <p>E395 36,00 €</p>	<p>geschliffen, teilweise Gelbgold beschichtet</p>  <p>Ø ca. 6 mm</p> <p>E396 37,00 €</p>

<p>matt, teilweise Gelbgold beschichtet</p>  <p>ca. 3x3 mm</p> <p>E413 37,00 €</p>	<p>matt, teilweise Gelbgold beschichtet</p>  <p>ca. 4x4 mm</p> <p>E414 38,00 €</p>	<p>matt, teilweise Gelbgold beschichtet</p>  <p>ca. 5x5 mm</p> <p>E415 39,00 €</p>	<p>matt, teilweise Gelbgold beschichtet</p>  <p>ca. 6x6 mm</p> <p>E416 40,00 €</p>
<p>matt, teilweise Gelbgold beschichtet</p>  <p>ca. 3x3 mm</p> <p>E433 37,00 €</p>	<p>matt, teilweise Gelbgold beschichtet</p>  <p>ca. 4x4 mm</p> <p>E434 38,00 €</p>	<p>matt, teilweise Gelbgold beschichtet</p>  <p>ca. 5x5 mm</p> <p>E435 39,00 €</p>	<p>matt, teilweise Gelbgold beschichtet</p>  <p>ca. 6x6 mm</p> <p>E436 40,00 €</p>
<p>matt, teilweise Roségold beschichtet</p>  <p>Ø ca. 3 mm</p> <p>E289 32,00 €</p>	<p>matt, teilweise Roségold beschichtet</p>  <p>Ø ca. 4 mm</p> <p>E290 33,00 €</p>	<p>matt, teilweise Roségold beschichtet</p>  <p>Ø ca. 5 mm</p> <p>E291 34,00 €</p>	<p>matt, teilweise Roségold beschichtet</p>  <p>Ø ca. 6 mm</p> <p>E292 35,00 €</p>
<p>geschliffen, teilweise Roségold beschichtet</p>  <p>Ø ca. 3 mm</p> <p>E397 34,00 €</p>	<p>geschliffen, teilweise Roségold beschichtet</p>  <p>Ø ca. 4 mm</p> <p>E398 35,00 €</p>	<p>geschliffen, teilweise Roségold beschichtet</p>  <p>Ø ca. 5 mm</p> <p>E399 36,00 €</p>	<p>geschliffen, teilweise Roségold beschichtet</p>  <p>Ø ca. 6 mm</p> <p>E400 37,00 €</p>
<p>matt, teilweise Roségold beschichtet</p>  <p>ca. 3x3 mm</p> <p>E417 37,00 €</p>	<p>matt, teilweise Roségold beschichtet</p>  <p>ca. 4x4 mm</p> <p>E418 38,00 €</p>	<p>matt, teilweise Roségold beschichtet</p>  <p>ca. 5x5 mm</p> <p>E419 39,00 €</p>	<p>matt, teilweise Roségold beschichtet</p>  <p>ca. 6x6 mm</p> <p>E420 40,00 €</p>
<p>matt, teilweise Roségold beschichtet</p>  <p>ca. 3x3 mm</p> <p>E437 37,00 €</p>	<p>matt, teilweise Roségold beschichtet</p>  <p>ca. 4x4 mm</p> <p>E438 38,00 €</p>	<p>matt, teilweise Roségold beschichtet</p>  <p>ca. 5x5 mm</p> <p>E439 39,00 €</p>	<p>matt, teilweise Roségold beschichtet</p>  <p>ca. 6x6 mm</p> <p>E440 40,00 €</p>

<p>matt, teilweise Altbronze beschichtet</p>  <p>Ø ca. 3 mm</p> <p>E293 32,00 €</p>	<p>matt, teilweise Altbronze beschichtet</p>  <p>Ø ca. 4 mm</p> <p>E294 33,00 €</p>	<p>matt, teilweise Altbronze beschichtet</p>  <p>Ø ca. 5 mm</p> <p>E295 34,00 €</p>	<p>matt, teilweise Altbronze beschichtet</p>  <p>Ø ca. 6 mm</p> <p>E296 35,00 €</p>
<p>geschliffen, teilweise Altbronze beschichtet</p>  <p>Ø ca. 3 mm</p> <p>E401 34,00 €</p>	<p>geschliffen, teilweise Altbronze beschichtet</p>  <p>Ø ca. 4 mm</p> <p>E402 35,00 €</p>	<p>geschliffen, teilweise Altbronze beschichtet</p>  <p>Ø ca. 5 mm</p> <p>E403 36,00 €</p>	<p>geschliffen, teilweise Altbronze beschichtet</p>  <p>Ø ca. 6 mm</p> <p>E404 37,00 €</p>
<p>matt, teilweise Altbronze beschichtet</p>  <p>ca. 3x3 mm</p> <p>E421 37,00 €</p>	<p>matt, teilweise Altbronze beschichtet</p>  <p>ca. 4x4 mm</p> <p>E422 38,00 €</p>	<p>matt, teilweise Altbronze beschichtet</p>  <p>ca. 5x5 mm</p> <p>E423 39,00 €</p>	<p>matt, teilweise Altbronze beschichtet</p>  <p>ca. 6x6 mm</p> <p>E424 40,00 €</p>
<p>matt, teilweise Altbronze beschichtet</p>  <p>ca. 3x3 mm</p> <p>E441 37,00 €</p>	<p>matt, teilweise Altbronze beschichtet</p>  <p>ca. 4x4 mm</p> <p>E442 38,00 €</p>	<p>matt, teilweise Altbronze beschichtet</p>  <p>ca. 5x5 mm</p> <p>E443 39,00 €</p>	<p>matt, teilweise Altbronze beschichtet</p>  <p>ca. 6x6 mm</p> <p>E444 40,00 €</p>
<p>matt, teilweise Schwarz beschichtet</p>  <p>Ø ca. 3 mm</p> <p>E297 32,00 €</p>	<p>matt, teilweise Schwarz beschichtet</p>  <p>Ø ca. 4 mm</p> <p>E298 33,00 €</p>	<p>matt, teilweise Schwarz beschichtet</p>  <p>Ø ca. 5 mm</p> <p>E299 34,00 €</p>	<p>matt, teilweise Schwarz beschichtet</p>  <p>Ø ca. 6 mm</p> <p>E300 35,00 €</p>
<p>geschliffen, teilweise Schwarz beschichtet</p>  <p>Ø ca. 3 mm</p> <p>E405 34,00 €</p>	<p>geschliffen, teilweise Schwarz beschichtet</p>  <p>Ø ca. 4 mm</p> <p>E406 35,00 €</p>	<p>geschliffen, teilweise Schwarz beschichtet</p>  <p>Ø ca. 5 mm</p> <p>E407 36,00 €</p>	<p>geschliffen, teilweise Schwarz beschichtet</p>  <p>Ø ca. 6 mm</p> <p>E408 37,00 €</p>

matt, teilweise
Schwarz beschichtet



ca. 3x3 mm
E425
37,00 €

matt, teilweise
Schwarz beschichtet



ca. 4x4 mm
E426
38,00 €

matt, teilweise
Schwarz beschichtet



ca. 5x5 mm
E427
39,00 €

matt, teilweise
Schwarz beschichtet



ca. 6x6 mm
E428
40,00 €

matt, teilweise
Schwarz beschichtet



ca. 3x3 mm
E445
37,00 €

matt, teilweise
Schwarz beschichtet



ca. 4x4 mm
E446
38,00 €

matt, teilweise
Schwarz beschichtet



ca. 5x5 mm
E447
39,00 €

matt, teilweise
Schwarz beschichtet



ca. 6x6 mm
E448
40,00 €

matt, Farbstein
Ø 4 mm



Ø ca. 5 mm
E200
30,50 €

matt, Farbstein
Ø 5 mm



Ø ca. 6 mm
E201
35,00 €



Farbsteinohrstecker sind
in diesen neun Farben erhältlich.



matt/gekratzt/poliert,
2x Brill. TW/SI
0,016 ct.



ca. 9x13 mm
E264
169 €

matt/gekratzt/
poliert,
2x Brill. TW/SI
0,016 ct.



ca. 14x50 mm
E261
189,00 €

matt/gekratzt/poliert



ca. 9x13 mm
E244
59,00 €

matt/gekratzt/
poliert



ca. 14x50 mm
E241
73,00 €

matt/poliert/gekratzt



ca. 10x12 mm
E555
95,00 €

matt/poliert/
gekratzt



ca. 19x22 mm
E558
146,00 €

matt/gekratzt/
poliert



ca. 10x12 mm,
L: ca. 120 mm
E589
111,00 €

matt/gekratzt/poliert,
teilweise Gelbgold
beschichtet, 2x Brill.
TW/SI 0,016 ct.



ca. 9x13 mm
E265
189,00 €

matt/gekratzt/
poliert, teilweise
Gelbgold
beschichtet,
2x Brill.
TW/SI
0,016 ct.



ca. 14x50 mm
E262
215,00 €

matt/gekratzt/poliert,
teilweise Gelbgold
beschichtet



ca. 9x13 mm
E245
79,00 €

matt/gekratzt/
poliert, teilweise
Gelbgold
beschichtet



ca. 14x50 mm
E242
99,00 €

matt/poliert/gekratzt,
teilweise
Gelbgold
beschichtet



ca. 10x12 mm
E556
116,50 €

matt/poliert/
gekratzt, teilweise
Gelbgold
beschichtet



ca. 19x22 mm
E559
166,50 €

matt/gekratzt/
poliert, teilweise
Gelbgold
beschichtet



ca. 10x12 mm,
L: ca. 120 mm
E590
135,00 €

matt/gekratzt/poliert,
teilweise Roségold
beschichtet. 2x Brill.
TW/SI 0,016 ct.



ca. 9x13 mm
E266
189,00 €

matt/gekratzt/
poliert, teilweise
Roségold
beschichtet,
2x Brill.
TW/SI
0,016 ct.



ca. 14x50 mm
E263
215,00 €

matt/gekratzt/poliert,
teilweise Roségold
beschichtet



ca. 9x13 mm
E246
79,00 €

matt/gekratzt/
poliert, teilweise
Roségold
beschichtet

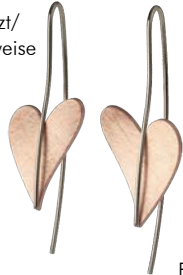

ca. 14x50 mm
E243
99,00 €

matt/poliert/gekratzt,
teilweise
Roségold
beschichtet



ca. 10x12 mm
E557
116,50 €

matt/poliert/
gekratzt, teilweise
Roségold
beschichtet



ca. 19x22 mm
E560
166,50 €

matt/gekratzt/
poliert, teilweise
Roségold
beschichtet



ca. 10x12 mm,
L: ca. 120 mm
E591
135,00 €

matt/gekratzt/
poliert, teilweise
Schwarz
beschichtet



ca. 9x13 mm
E306
79,00 €

matt/gekratzt/
poliert, teilweise
Schwarz
beschichtet



ca. 14x50 mm
E302
99,00 €

matt/gekratzt



Ø ca. 7 mm

E467
43,50 €

matt/gekratzt



ca. 10x21 mm

E516
57,50 €

matt/gekratzt

- Stift mittig -



ca. 10x21 mm

E540
57,50 €

poliert/gekratzt



Ø ca. 20 mm

E623
89,00 €

poliert/gekratzt



Ø ca. 20 mm

E626
89,00 €

geschliffen/poliert



Ø ca. 12 mm

E326
59,00 €

matt/poliert



ca. 3,5x14,5 mm

E705
29,00 €

matt/poliert



ca. 6x14,5 mm

E707
32,00 €

matt/poliert



B: ca. 3,5 mm,
Ø ca. 16 mm

E713
59,00 €

matt/poliert



B: ca. 3,5 mm,
Ø ca. 40 mm

E715
75,00 €

poliert,
Zirkonia white



ca. 2x19 mm

E569
78,50 €

poliert,
Zirkonia white
teilausgefasst



Ø ca. 25 mm

E629
149,00 €

matt/poliert,
Zirkonia white



Ø ca. 3 mm

E458.WH
41,00 €

matt/poliert,
Zirkonia white



Ø ca. 4 mm

E461.WH
43,50 €

matt/poliert,
Zirkonia white



Ø ca. 5 mm

E464.WH
46,50 €

poliert, Zirkonia white



Ø ca. 6 mm

E455.WH
69,00 €

poliert, Zirkonia white



Ø ca. 9 mm

E452.WH
88,00 €

poliert, Zirkonia white



Ø ca. 9 mm

E449.WH
76,00 €

matt/poliert,
Zirkonia white



ca. 3,5x14,5 mm

E709
45,00 €

matt/poliert,
Zirkonia white



ca. 6x14,5 mm

E711
49,00 €

matt/poliert,
Zirkonia white



B: ca. 3,5 mm,
Ø ca. 16 mm

E717
79,00 €

matt/poliert,
Zirkonia white



B: ca. 3,5 mm,
Ø ca. 40 mm

E719
109,00 €

matt/poliert,
Zirkonia white



B: ca. 2 mm,
Ø ca. 14 mm

E721
88,00 €

matt/gekratzt,
Gelbgold beschichtet



Ø ca. 7 mm

E468
56,00 €

matt/gekratzt,
Gelbgold
beschichtet



ca. 10x21 mm

E517
74,50 €

matt/gekratzt,
Gelbgold
beschichtet

- Stift mittig -



ca. 10x21 mm

E541
74,50 €

poliert/gekratzt,
Gelbgold
beschichtet



Ø ca. 20 mm

E624
119,00 €

poliert/gekratzt,
Gelbgold
beschichtet



Ø ca. 20 mm

E627
119,00 €

geschliffen/poliert,
Gelbgold
beschichtet



Ø ca. 12 mm

E327
70,50 €

matt/poliert,
Gelbgold
beschichtet



ca. 3,5x14,5 mm

E706
45,00 €

matt/poliert,
Gelbgold
beschichtet



ca. 6x14,5 mm

E708
48,00 €

matt/poliert,
Gelbgold
beschichtet



B: ca. 3,5 mm,
Ø ca. 16 mm

E714
45,00 €

matt/poliert,
Gelbgold
beschichtet



B: ca. 3,5 mm,
Ø ca. 40 mm

E716
99,00 €

poliert,
Gelbgold
beschichtet,
Zirkonia white



ca. 2x19 mm

E570
104,00 €

poliert, Gelb-
gold beschich-
tet, Zirkonia
white teil-
ausge-
fasst



Ø ca. 25 mm

E630
179,00 €

matt/poliert,
Gelbgold
beschichtet,
Zirkonia white



Ø ca. 3 mm

E459.WH
53,50 €

matt/poliert,
Gelbgold
beschichtet,
Zirkonia white



Ø ca. 4 mm

E462.WH
56,00 €

matt/poliert,
Gelbgold
beschichtet,
Zirkonia white



Ø ca. 5 mm

E465.WH
59,00 €

poliert,
teilweise Gelbgold
beschichtet,
Zirkonia white



Ø ca. 6 mm

E456.WH
82,50 €

poliert,
teilweise Gelbgold
beschichtet,
Zirkonia white



Ø ca. 9 mm

E453.WH
104,00 €

poliert,
teilweise Gelbgold
beschichtet,
Zirkonia white



Ø ca. 9 mm

E450.WH
92,00 €

matt/poliert,
Gelbgold
beschichtet,
Zirkonia white



ca. 3,5x14,5 mm

E710
59,00 €

matt/poliert,
Gelbgold
beschichtet,
Zirkonia white



ca. 6x14,5 mm

E712
64,00 €

matt/poliert,
Gelbgold
beschichtet,
Zirkonia white



B: ca. 3,5 mm,
Ø ca. 16 mm

E718
99,00 €

matt/poliert,
Gelbgold
beschichtet,
Zirkonia white



B: ca. 3,5 mm,
Ø ca. 40 mm

E720
135,00 €

matt/poliert,
Gelbgold
beschichtet,
Zirkonia white



B: ca. 2 mm,
Ø ca. 14 mm

E722
111,00 €

poliert/gekratzt,
Roségold
beschichtet



edia

Ø ca. 20 mm

E625
119,00 €

poliert/gekratzt,
Roségold
beschichtet



edia

Ø ca. 20 mm

E628
119,00 €

matt/gekratzt,
Roségold
beschichtet

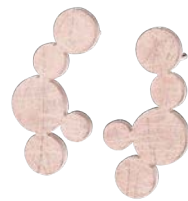

ca. 10x21 mm

E518
74,50 €

matt/gekratzt,
Roségold
beschichtet

- Stiff mittig -



ca. 10x21 mm

E542
74,50 €

matt/gekratzt,
Roségold
beschichtet



Ø ca. 7 mm

E469
56,00 €

geschliffen/poliert,
Roségold
beschichtet



Ø ca. 12 mm

E328
70,50 €

poliert,
Roségold
beschichtet,
Zirkonia white



ca. 2x19 mm

E571
104,00 €

poliert, Rosé-
gold beschich-
tet, Zirkonia
white teil-
ausge-
fasst

edia

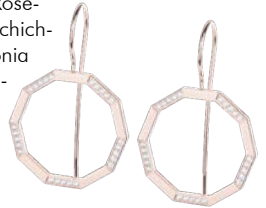

Ø ca. 25 mm

E631
179,00 €

matt/poliert,
Roségold
beschichtet,
Zirkonia white



Ø ca. 3 mm

E460.WH
53,50 €

matt/poliert,
Roségold
beschichtet,
Zirkonia white



Ø ca. 4 mm

E463.WH
56,00 €

matt/poliert,
Roségold
beschichtet,
Zirkonia white



Ø ca. 5 mm

E466.WH
59,00 €

poliert,
teilweise Roségold
beschichtet,
Zirkonia white



Ø ca. 6 mm

E457.WH
82,50 €

poliert,
teilweise Roségold
beschichtet,
Zirkonia white



Ø ca. 9 mm

E454.WH
104,00 €

poliert,
teilweise Roségold
beschichtet,
Zirkonia white



Ø ca. 9 mm

E451.WH
92,00 €

matt/poliert,
Roségold
beschichtet,
Zirkonia white



B: ca. 2 mm,
Ø ca. 14 mm

E723
111,00 €

poliert,
2x Crystal
White Pearl



Ø ca. 12 mm

E329.WHP
59,00 €

poliert,
2x SW-Button-Perle
Ø ca. 5 mm



Ø ca. 6 mm

E476
43,50 €

poliert,
2x SW-Button-Perle
Ø ca. 6 mm



Ø ca. 7 mm

E479
46,50 €

poliert,
Gelbgold
beschichtet,
2x Crystal
White Pearl



Ø ca. 12 mm

E385.WHP
69,00 €

matt/poliert, Gelbgold
beschichtet, 2x SW-Button-Perle
Ø ca. 5 mm



Ø ca. 6 mm

E477
56,00 €

matt/poliert, Gelbgold
beschichtet, 2x SW-Button-Perle
Ø ca. 6 mm



Ø ca. 7 mm

E480
59,00 €

poliert,
Roségold
beschichtet,
2x Crystal
White Pearl



Ø ca. 12 mm

E386.WHP
69,00 €

poliert, Roségold
beschichtet, 2x SW-Button-Perle
Ø ca. 5 mm



Ø ca. 6 mm

E478
56,00 €

poliert, Roségold
beschichtet, 2x SW-Button-Perle
Ø ca. 6 mm



Ø ca. 7 mm

E481
59,00 €

matt/polier



Ø ca. 14 mm,
B: ca. 4 mm

E575
66,00 €

matt/polier



Ø ca. 14 mm,
B: ca. 6 mm

E579
69,00 €

poliert



Ø ca. 14 mm,
B: ca. 4 mm

E576
66,00 €

poliert



Ø ca. 14 mm,
B: ca. 6 mm

E580
69,00 €

matt/polier,
Zirkonia white



Ø ca. 14 mm,
B: ca. 4 mm

E583
116,50 €

matt/polier,
Zirkonia white



Ø ca. 14 mm,
B: ca. 6 mm

E586
113,50 €

matt/polier,
Gelbgold
beschichtet

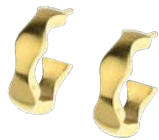

Ø ca. 14 mm,
B: ca. 4 mm

E577
85,50 €

matt/polier,
Gelbgold
beschichtet

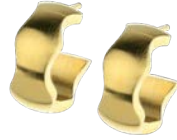

Ø ca. 14 mm,
B: ca. 6 mm

E581
88,00 €

matt/polier,
Gelbgold
beschichtet,
Zirkonia white



Ø ca. 14 mm,
B: ca. 4 mm

E584
134,00 €

matt/polier,
Gelbgold
beschichtet,
Zirkonia white



Ø ca. 14 mm,
B: ca. 6 mm

E587
135,00 €

matt/polier,
Roségold
beschichtet,
Zirkonia white



Ø ca. 14 mm,
B: ca. 6 mm

E588
135,00 €

matt/polier,
Roségold
beschichtet



Ø ca. 14 mm,
B: ca. 4 mm

E578
85,50 €

matt/polier,
Roségold
beschichtet



Ø ca. 14 mm,
B: ca. 6 mm

E582
88,00 €

matt/polier,
Roségold
beschichtet,
Zirkonia white



Ø ca. 14 mm,
B: ca. 4 mm

E585
134,00 €

poliert



Ø ca. 14 mm,
B: ca. 2 mm

E597
69,00 €

poliert



Ø ca. 14 mm,
B: ca. 4 mm

E603
75,00 €

poliert,
Zirkonia white
teilausgefasst



Ø ca. 14 mm,
B: ca. 2 mm

E600
85,00 €

poliert,
Zirkonia white
teilausgefasst



Ø ca. 14 mm,
B: ca. 4 mm

E606
95,00 €

poliert, Gelbgold
beschichtet



Ø ca. 14 mm,
B: ca. 2 mm

E598
89,00 €

poliert, Gelbgold
beschichtet



Ø ca. 14 mm,
B: ca. 4 mm

E604
95,00 €

poliert, Gelbgold
beschichtet,
Zirkonia white
teilausgefasst



Ø ca. 14 mm,
B: ca. 2 mm

E601
105,00 €

poliert, Gelbgold
beschichtet,
Zirkonia white
teilausgefasst



Ø ca. 14 mm,
B: ca. 4 mm

E607
115,00 €

poliert, Roségold
beschichtet



Ø ca. 14 mm,
B: ca. 2 mm

E599
89,00 €

poliert, Roségold
beschichtet



Ø ca. 14 mm,
B: ca. 4 mm

E605
95,00 €

poliert, Roségold
beschichtet,
Zirkonia white
teilausgefasst



Ø ca. 14 mm,
B: ca. 2 mm

E602
105,00 €

poliert, Roségold
beschichtet,
Zirkonia white
teilausgefasst



Ø ca. 14 mm,
B: ca. 4 mm

E608
115,00 €

poliert



Ø ca. 34 mm,
B: ca. 2 mm

E543
69,00 €

poliert



Ø ca. 49 mm,
B: ca. 2 mm

E546
78,50 €

poliert,
Zirkonia white
teilausgefasst



Ø ca. 34 mm,
B: ca. 2 mm

E549
95,00 €

poliert,
Zirkonia white
teilausgefasst



Ø ca. 49 mm,
B: ca. 2 mm

E552
104,00 €

poliert, Gelbgold
beschichtet



Ø ca. 34 mm,
B: ca. 2 mm

E544
97,50 €

poliert, Gelbgold
beschichtet



Ø ca. 49 mm,
B: ca. 2 mm

E547
111,00 €

poliert, Gelbgold
beschichtet,
Zirkonia white
teilausgefasst



Ø ca. 34 mm,
B: ca. 2 mm

E550
123,00 €

poliert, Gelbgold
beschichtet,
Zirkonia white
teilausgefasst



Ø ca. 49 mm,
B: ca. 2 mm

E553
132,50 €

poliert, Roségold
beschichtet

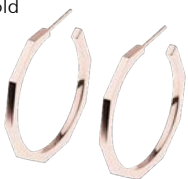

Ø ca. 34 mm,
B: ca. 2 mm

E545
97,50 €

poliert, Roségold
beschichtet



Ø ca. 49 mm,
B: ca. 2 mm

E548
111,00 €

poliert, Roségold
beschichtet,
Zirkonia white
teilausgefasst



Ø ca. 34 mm,
B: ca. 2 mm

E551
123,00 €

poliert, Roségold
beschichtet,
Zirkonia white
teilausgefasst



Ø ca. 49 mm,
B: ca. 2 mm

E554
132,50 €

poliert



B: ca. 3 mm,
Ø ca. 12 mm

E632
39,00 €

poliert



B: ca. 5 mm,
Ø ca. 12 mm

E638
42,00 €

poliert



B: ca. 7 mm,
Ø ca. 12 mm

E644
45,00 €

poliert



B: ca. 3 mm,
Ø ca. 16 mm

E650
45,00 €

poliert



B: ca. 5 mm,
Ø ca. 16 mm

E656
48,00 €

poliert



B: ca. 7 mm,
Ø ca. 16 mm

E662
51,00 €

matt/polier



B: ca. 3 mm,
Ø ca. 12 mm

E634
39,00 €

matt/polier



B: ca. 5 mm,
Ø ca. 12 mm

E640
42,00 €

matt/poliert



B: ca. 7 mm,
Ø ca. 12 mm

E646
45,00 €

matt/poliert



B: ca. 3 mm,
Ø ca. 16 mm

E652
45,00 €

matt/poliert



B: ca. 5 mm,
Ø ca. 16 mm

E658
48,00 €

matt/poliert



B: ca. 7 mm,
Ø ca. 16 mm

E664
51,00 €

gekratzt/poliert



B: ca. 3 mm,
Ø ca. 12 mm

E636
39,00 €

gekratzt/poliert



B: ca. 5 mm,
Ø ca. 12 mm

E642
42,00 €

gekratzt/poliert



B: ca. 7 mm,
Ø ca. 12 mm

E648
45,00 €

gekratzt/poliert



B: ca. 3 mm,
Ø ca. 16 mm

E654
45,00 €

gekratzt/poliert

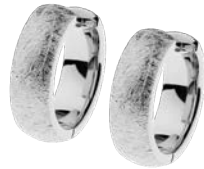

B: ca. 5 mm,
Ø ca. 16 mm

E660
48,00 €

gekratzt/poliert

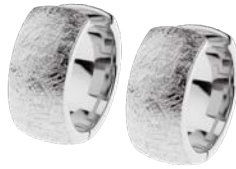

B: ca. 7 mm,
Ø ca. 16 mm

E666
51,00 €

poliert, Gelbgold
beschichtet



B: ca. 3 mm,
Ø ca. 12 mm

E633
49,00 €

poliert, Gelbgold
beschichtet



B: ca. 5 mm,
Ø ca. 12 mm

E639
54,00 €

poliert, Gelbgold
beschichtet



B: ca. 7 mm,
Ø ca. 12 mm

E645
59,00 €

poliert, Gelbgold
beschichtet



B: ca. 3 mm,
Ø ca. 16 mm

E651
55,00 €

poliert, Gelbgold
beschichtet



B: ca. 5 mm,
Ø ca. 16 mm

E657
60,00 €

poliert, Gelbgold
beschichtet



B: ca. 7 mm,
Ø ca. 16 mm

E663
65,00 €

matt/poliert,
Gelbgold
beschichtet



B: ca. 3 mm,
Ø ca. 12 mm

E635
49,00 €

matt/poliert,
Gelbgold
beschichtet



B: ca. 5 mm,
Ø ca. 12 mm

E641
54,00 €

matt/poliert,
Gelbgold
beschichtet



B: ca. 7 mm,
Ø ca. 12 mm

E647
59,00 €

matt/poliert,
Gelbgold
beschichtet



B: ca. 3 mm,
Ø ca. 16 mm

E653
55,00 €

matt/poliert,
Gelbgold
beschichtet



B: ca. 5 mm,
Ø ca. 16 mm

E659
60,00 €

matt/poliert,
Gelbgold
beschichtet



B: ca. 7 mm,
Ø ca. 16 mm

E665
65,00 €

gekratzt/poliert,
Gelbgold
beschichtet



B: ca. 3 mm,
Ø ca. 12 mm

E637
49,00 €

gekratzt/poliert,
Gelbgold
beschichtet



B: ca. 5 mm,
Ø ca. 12 mm

E643
54,00 €



gekratzt/polirt,
Gelbgold
beschichtet
B: ca. 7 mm,
Ø ca. 12 mm
E649
59,00 €



gekratzt/polirt,
Gelbgold
beschichtet
B: ca. 3 mm,
Ø ca. 16 mm
E655
55,00 €



gekratzt/polirt,
Gelbgold
beschichtet
B: ca. 5 mm,
Ø ca. 16 mm
E661
60,00 €



gekratzt/polirt,
Gelbgold
beschichtet
B: ca. 7 mm,
Ø ca. 16 mm
E667
65,00 €



matt/polirt/
gekratzt
Creolen-Einhänger
ca. 7x19 mm
EH07
42,00 €



polirt,
Zirkonia white
Creolen-Einhänger
ca. 7x19 mm
EH13
45,00 €



polirt,
Zirkonia white
evia
Creolen-Einhänger
ca. 7x21 mm
EH11
45,00 €



polirt,
SW-Button-
Perlen
Ø ca. 6 mm
Creolen-Einhänger
ca. 7x23 mm
EH09
45,00 €



matt/polirt/gekratzt
(E654+EH07)
Creole: B: ca. 3 mm,
Ø ca. 16mm;
Einhänger:
ca. 7x19 mm
E687
87,00 €

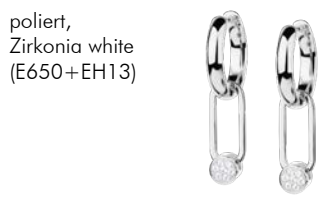

polirt,
Zirkonia white
(E650+EH13)
Creole: B: ca. 3 mm,
Ø ca. 16mm;
Einhänger:
ca. 7x19 mm
E693
90,00 €

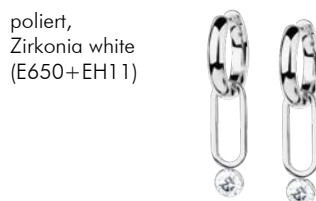

polirt,
Zirkonia white
(E650+EH11)
Creole: B: ca. 3 mm,
Ø ca. 16mm;
Einhänger:
ca. 7x21 mm
E691
90,00 €

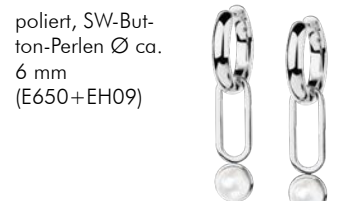

polirt, SW-But-
ton-Perlen Ø ca.
6 mm
(E650+EH09)
Creole: B: ca. 3 mm,
Ø ca. 16mm;
Einhänger:
ca. 7x23 mm
E689
90,00 €



matt/polirt/
gekratzt,
Gelbgold
beschichtet
Creolen-Einhänger
ca. 7x19 mm
EH08
56,00 €



polirt, Gelbgold
beschichtet,
Zirkonia white
Creolen-Einhänger
ca. 7x19 mm
EH14
59,00 €



polirt, Gelbgold
beschichtet,
Zirkonia white
Creolen-Einhänger
ca. 7x21 mm
EH12
59,00 €



polirt, Gelbgold
beschichtet,
SW-Button-
Perlen
Ø ca. 6 mm
Creolen-Einhänger
ca. 7x23 mm
EH10
59,00 €



matt/polirt/
gekratzt,
Gelbgold
beschichtet,
(E655+EH07)
Creole: B: ca. 3 mm,
Ø ca. 16mm;
Einhänger:
ca. 7x19 mm
E688
111,00 €

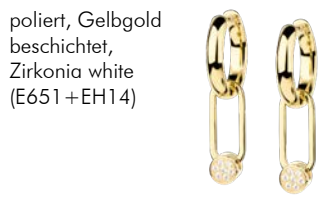

polirt, Gelbgold
beschichtet,
Zirkonia white
(E651+EH14)
Creole: B: ca. 3 mm,
Ø ca. 16mm;
Einhänger:
ca. 7x19 mm
E694
114,00 €



polirt, Gelbgold
beschichtet,
Zirkonia white
(E651+EH12)
Creole: B: ca. 3 mm,
Ø ca. 16mm;
Einhänger:
ca. 7x21 mm
E692
114,00 €



polirt, Gelbgold
beschichtet,
SW-Button-
Perlen
Ø ca. 6 mm
(E651+EH10)
Creole: B: ca. 3 mm,
Ø ca. 16mm;
Einhänger:
ca. 7x23 mm
E690
114,00 €

matt/polirt,
Brill. TW/SI 0,02 ct.,
Spiegelankerkette Ø 1 mm



L: ca. 16, 17, 18, 19, 20, 21 cm,
mit Clic-Verschluss Ø 2 mm

A571
176,00 €

matt/polirt,
Brill. TW/SI 0,02 ct.



B: ca. 2 mm,
klein, mittel, groß

A570
146,00 €

matt/polirt,
SW-Perle Ø ca. 4 mm,
Spiegelankerkette Ø 1 mm



L: ca. 16, 17, 18, 19, 20, 21 cm,
mit Clic-Verschluss Ø 2 mm

A572
95,00 €

polirt,
Brill. TW/SI 0,02 ct.,
Spiegelankerkette Ø 1 mm



L: 16, 17, 18, 19, 20, 21 cm,
mit Clic-Verschluss Ø 2 mm

A592
175,00 €

polirt



L: ca. 16, 17, 18, 19, 20, 21 cm,
mit Clic-Verschluss Ø 2 mm

A591
59,00 €

matt/polirt,
Spiegelankerkette Ø 1,5 mm



L: ca. 16, 17, 18, 19, 20, 21 cm,
mit Clic-Verschluss Ø 2 mm

A596
85,00 €

matt/polirt,
teilweise Gelbgold
beschichtet,
Spiegelankerkette Ø 1,5 mm



L: ca. 16, 17, 18, 19, 20, 21 cm,
mit Clic-Verschluss Ø 2 mm

A597
95,00 €

matt/gekratzt/polirt,
Spiegelankerkette Ø 1,5 mm



L: ca. 16, 17, 18, 19, 20, 21 cm,
mit Clic-Verschluss Ø 2 mm

A586
104,00 €

matt/gekratzt/polirt,
teilweise Gelbgold beschichtet,
Spiegelankerkette Ø 1,5 mm



L: ca. 16, 17, 18, 19, 20, 21 cm,
mit Clic-Verschluss Ø 2 mm

A587
116,50 €

matt/gekratzt/polirt,
teilweise Roségold beschichtet,
Spiegelankerkette Ø 1,5 mm



L: ca. 16, 17, 18, 19, 20, 21 cm,
mit Clic-Verschluss Ø 2 mm

A588
116,50 €

polirt, SW-Perle Ø ca. 4 mm,
Spiegelankerkette Ø 1,5 mm



L: ca. 16, 17, 18, 19, 20, 21 cm,
mit Clic-Verschluss Ø 2 mm

A593
95,00 €

poliert/gekratzt/matt,
Spiegelankerkette Ø 1,5 mm



L: ca. 16, 17, 18, 19, 20, 21 cm,
mit Clic-Verschluss Ø 2 mm

A594
104,00 €

matt/gekratzt/polirt,
teilweise Gelbgold
beschichtet,
Spiegelankerkette Ø 1,5 mm



L: ca. 16, 17, 18, 19, 20, 21 cm,
mit Clic-Verschluss Ø 2 mm

A595
116,00 €

matt/polirt/gekratzt



B: ca. 13 mm,
klein, mittel, groß

A589
109,00 €

matt/polirt/gekratzt,
teilweise Gelbgold beschichtet



B: ca. 13 mm,
klein, mittel, groß

A590
159,00 €

matt/polirt,
SW-Perle Ø ca. 8 mm



B: ca. 13 mm,
klein, mittel, groß

A48
146,00 €

matt, teilweise Gelbgold beschichtet,
SW-Perle Ø ca. 8 mm



B: ca. 13 mm,
klein, mittel, groß

A49
185,00 €

matt/polirt,
SW-Perle Ø ca. 4 mm,
Spiegelankerkette Ø 1,5 mm



L: ca. 16, 17, 18, 19, 20, 21 cm,
mit Clic-Verschluss Ø 2 mm

A620
95,00 €

matt/polirt,
teilweise Gelbgold beschichtet,
SW-Perle Ø ca. 4 mm,
Spiegelankerkette Ø 1,5 mm



L: ca. 16, 17, 18, 19, 20, 21 cm,
mit Clic-Verschluss Ø 2 mm

A621
109,00 €

matt/polirt,
Gelbgold beschichtet,
SW-Perle Ø ca. 4 mm,
Spiegelankerkette Ø 1,5 mm



L: ca. 16, 17, 18, 19, 20, 21 cm,
mit Clic-Verschluss Ø 2 mm

A622
125,00 €

matt, Leder hellbraun,
dunkelbraun, schwarz

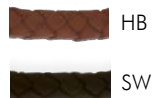

Ø ca. 6 mm,
L: ca. 19, 20, 21 cm

A55.HB A55.DB A55.SW
je 69,00 €

matt, Leder hellbraun,
dunkelbraun, schwarz



Ø ca. 6 mm,
L: ca. 19, 20, 21 cm

A56.HB A56.DB A56.SW
je 69,00 €

matt/poliert,
facettierter Hämatit,
Spiegelankerkette Ø 1,5 mm



Ø ca. 12/19 mm,
L: ca. 16, 17, 18, 19, 20, 21 cm,
mit Clic-Verschluss Ø 2 mm

A623
109,00 €

matt/poliert, teilweise Gelbgold
beschichtet, facettierter
Hämatit, Spiegelankerkette
Ø 1,5 mm



Ø ca. 12/19 mm,
L: ca. 16, 17, 18, 19, 20, 21 cm,
mit Clic-Verschluss Ø 2 mm

A624
129,00 €

matt/poliert, Gelbgold beschichtet,
facettierter Hämatit,
Spiegelankerkette Ø 1,5 mm



Ø ca. 12/19 mm,
L: ca. 16, 17, 18, 19, 20, 21 cm,
mit Clic-Verschluss Ø 2 mm

A625
145,00 €

matt, facettierter Hämatit



L: ca. 16, 17, 18, 19, 20, 21 cm,
mit Clic-Verschluss Ø 2 mm

A629
69,00 €

matt, teilweise Gelbgold beschichtet,
facettierter Hämatit



L: ca. 16, 17, 18, 19, 20, 21 cm,
mit Clic-Verschluss Ø 2 mm

A630
79,00 €

matt, facettierter Hämatit,
Spiegelankerkette Ø 1,5 mm



L: ca. 16, 17, 18, 19, 20, 21 cm,
mit Clic-Verschluss Ø 2 mm

A635
89,00 €

matt, Gelbgold beschichtet,
facettierter Hämatit,
Spiegelankerkette Ø 1,5 mm



L: ca. 16, 17, 18, 19, 20, 21 cm,
mit Clic-Verschluss Ø 2 mm

A636
105,00 €

matt/poliert, facettierter
Granat, Spiegelankerkette
Ø 1,5 mm



Ø ca. 12/19 mm,
L: ca. 16, 17, 18, 19, 20, 21 cm,
mit Clic-Verschluss Ø 2 mm

A626
109,00 €

matt/poliert, teilweise Gelbgold
beschichtet, facettierter Granat,
Spiegelankerkette
Ø 1,5 mm



Ø ca. 12/19 mm,
L: ca. 16, 17, 18, 19, 20, 21 cm,
mit Clic-Verschluss Ø 2 mm

A627
129,00 €

matt/poliert, Gelbgold beschichtet,
facettierter Granat,
Spiegelankerkette
Ø 1,5 mm



Ø ca. 12/19 mm,
L: ca. 16, 17, 18, 19, 20, 21 cm,
mit Clic-Verschluss Ø 2 mm

A628
145,00 €

matt, facettierter
Granat



L: ca. 16, 17, 18, 19, 20, 21 cm,
mit Clic-Verschluss Ø 2 mm

A631
69,00 €

matt, teilweise Gelbgold beschichtet,
facettierter Granat



L: ca. 16, 17, 18, 19, 20, 21 cm,
mit Clic-Verschluss Ø 2 mm

A632
79,00 €

matt,
facettierter Granat,
Spiegelankerkette Ø 1,5 mm



L: ca. 16, 17, 18, 19, 20, 21 cm,
mit Clic-Verschluss Ø 2 mm

A637
89,00 €

matt, Gelbgold beschichtet,
facettierter Granat,
Spiegelankerkette Ø 1,5 mm



L: ca. 16, 17, 18, 19, 20, 21 cm,
mit Clic-Verschluss Ø 2 mm

A638
105,00 €

matt, facettierter
Peridot



L: ca. 16, 17, 18, 19, 20, 21 cm,
mit Clic-Verschluss Ø 2 mm

A633
69,00 €

matt, teilweise Gelbgold beschichtet,
facettierter Peridot



L: ca. 16, 17, 18, 19, 20, 21 cm,
mit Clic-Verschluss Ø 2 mm

A634
79,00 €

Königsarmband

matt/poliert



Ø ca. 9 mm,
L: ca. 19, 20, 21 cm,
mit Magnetverschluss groß mit Gewinde

A59
97,50 €

Olivenarmband

matt/poliert



Ø ca. 12 mm,
L: ca. 19, 20, 21 cm,
mit Magnetverschluss groß mit Gewinde

A87
120,50 €

Strickarmband

matt



Ø ca. 7 mm,
L: ca. 19, 20, 21 cm,
mit Magnetverschluss groß mit Gewinde

A73
66,00 €

matt/poliert



Ø ca. 12 mm,
L: ca. 19, 20, 21 cm,
mit Magnetverschluss groß mit Gewinde

A74
134,00 €

Königsarmband

matt/polier



Ø ca. 5 mm,
L: ca. 19, 20, 21 cm,
mit Magnetverschluss groß mit Gewinde

A79
85,50 €

Zopfarmband

matt/polier



Ø ca. 8 mm,
L: ca. 19, 20, 21 cm,
mit Magnetverschluss groß mit Gewinde

A81
78,50 €

matt/polier



Ø ca. 8 mm,
L: ca. 19, 20, 21 cm,
mit Magnetverschluss groß mit Gewinde

A91
97,50 €

matt, Leder hellbraun,
dunkelbraun, schwarz



Ø ca. 8 mm,
L: ca. 19, 20, 21 cm,
mit Magnetverschluss groß mit Gewinde

A60.HB A60.DB A60.SW
je 76,00 €

Königsarmband

matt/polier, teilweise
Gelbgold beschichtet



Ø ca. 9 mm,
L: ca. 19, 20, 21 cm,
mit Magnetverschluss groß mit Gewinde

A84
130,00 €

Königsarmband

matt/polier, teilweise
Roségold beschichtet



Ø ca. 9 mm,
L: ca. 19, 20, 21 cm,
mit Magnetverschluss groß mit Gewinde

A85
130,00 €

Königsarmband

matt/polier, teilweise
Schwarz beschichtet



Ø ca. 9 mm,
L: ca. 19, 20, 21 cm,
mit Magnetverschluss groß mit Gewinde

A86
130,00 €

Olivenarmband

matt/polier, teilweise
Gelbgold beschichtet



Ø ca. 12 mm,
L: ca. 19, 20, 21 cm,
mit Magnetverschluss groß mit Gewinde

A88
130,00 €

Olivenarmband

matt/polier, teilweise
Roségold beschichtet



Ø ca. 12 mm,
L: ca. 19, 20, 21 cm,
mit Magnetverschluss groß mit Gewinde

A89
130,00 €

antik-matt



Ø ca. 6 mm,
L: ca. 19, 20, 21, 22, 23 cm,
mit Magnetverschluss klein ohne Gewinde

A532
76,00 €

poliert



Ø ca. 6,5 mm,
L: ca. 19, 20, 21 cm,
mit Magnetverschluss klein ohne Gewinde

A533
123,00 €

matt/polier



Ø ca. 8 mm,
L: ca. 19, 20, 21 cm,
mit Magnetverschluss klein ohne Gewinde

A528
97,50 €

matt/polier



Ø ca. 5 mm,
L: ca. 19, 20, 21 cm,
mit Magnetverschluss klein ohne Gewinde

A529
66,00 €

Königsarmband

matt/polier



Ø ca. 5 mm,
L: ca. 19, 20, 21 cm,
mit Magnetverschluss klein ohne Gewinde

A524
85,50 €

Königsarmband

matt/polier, teilweise
Gelbgold beschichtet



Ø ca. 5 mm,
L: ca. 19, 20, 21 cm,
mit Magnetverschluss klein ohne Gewinde

A525
116,50 €

Königsarmband

matt/polier, teilweise
Roségold beschichtet



Ø ca. 5 mm,
L: ca. 19, 20, 21 cm,
mit Magnetverschluss klein ohne Gewinde

A526
116,50 €

Königsarmband

matt/polier, teilweise
Schwarz beschichtet



Ø ca. 5 mm,
L: ca. 19, 20, 21 cm,
mit Magnetverschluss klein ohne Gewinde

A527
116,50 €

antik-matt



Ø ca. 5 mm,
L: ca. 19, 20, 21, 22, 23 cm,
mit Magnetverschluss klein ohne Gewinde

A534
76,00 €

matt, black-cord



Ø ca. 6 mm,
L: ca. 19, 20, 21, 22, 23 cm,
mit Magnetverschluss klein ohne Gewinde

A542
76,00 €

matt, Schwarz beschichtet,
black-cord



Ø ca. 6 mm,
L: ca. 19, 20, 21, 22, 23 cm,
mit Magnetverschluss klein ohne Gewinde

A543
76,00 €

polierte Drachen-
Venen-Achat-Würfel



Ø ca. 8 mm,
L: ca. 19, 20, 21, 22, 23 cm,
mit Magnetverschluss klein ohne Gewinde

A541
79,00 €

matte Onyx-Perlen



Ø ca. 6 mm,
L: ca. 19, 20, 21, 22, 23 cm,
mit Magnetverschluss klein ohne Gewinde

A520
76,00 €

matte Onyx-Perlen



Ø ca. 8 mm,
L: ca. 19, 20, 21, 22, 23 cm,
mit Magnetverschluss klein ohne Gewinde

A521
78,50 €

matte Onyx-Linsen



Ø ca. 6 mm,
L: ca. 19, 20, 21, 22, 23 cm,
mit Magnetverschluss klein ohne Gewinde

A530
76,00 €

matte Onyx-Linsen



Ø ca. 8 mm,
L: ca. 19, 20, 21, 22, 23 cm,
mit Magnetverschluss klein ohne Gewinde

A531
78,50 €

matte Silberauge-Perlen



Ø ca. 6 mm,
L: ca. 19, 20, 21, 22, 23 cm,
mit Magnetverschluss klein ohne Gewinde

A535
76,00 €

matte Silberauge-Perlen



Ø ca. 8 mm,
L: ca. 19, 20, 21, 22, 23 cm,
mit Magnetverschluss klein ohne Gewinde

A536
79,00 €

matte Holzjaspis-Perlen



Ø ca. 6 mm,
L: ca. 19, 20, 21, 22, 23 cm,
mit Magnetverschluss klein ohne Gewinde

A537
76,00 €

matte Holzjaspis-Perlen



Ø ca. 8 mm,
L: ca. 19, 20, 21, 22, 23 cm,
mit Magnetverschluss klein ohne Gewinde

A538
79,00 €

matte Sodalith-Perlen



Ø ca. 6 mm,
L: ca. 19, 20, 21, 22, 23 cm,
mit Magnetverschluss klein ohne Gewinde

A539
76,00 €

matte Sodalith-Perlen



Ø ca. 8 mm,
L: ca. 19, 20, 21, 22, 23 cm,
mit Magnetverschluss klein ohne Gewinde

A540
79,00 €

Süßwasserperlen



Ø ca. 6 mm,
L: ca. 19, 20, 21 cm,
mit Magnetverschluss klein ohne Gewinde

A522
101,50 €

Süßwasserperlen



Ø ca. 8 mm,
L: ca. 19, 20, 21 cm,
mit Magnetverschluss klein ohne Gewinde

A523
164,00 €

poliert



B: ca. 2 mm,
klein, mittel, groß

A574
82,50 €

poliert



B: ca. 4 mm,
klein, mittel, groß

A577
88,00 €

poliert, Zirkonia white teilausgefasst



B: ca. 2 mm,
klein, mittel, groß

A580
130,00 €

poliert, Zirkonia white teilausgefasst



B: ca. 9 mm,
klein, mittel, groß

A583
178,50 €

poliert, Gelbgold beschichtet



B: ca. 2 mm,
klein, mittel, groß

A575
111,00 €

poliert, Gelbgold beschichtet



B: ca. 4 mm,
klein, mittel, groß

A578
119,00 €

poliert, Gelbgold beschichtet,
Zirkonia white teilausgefasst



B: ca. 2 mm,
klein, mittel, groß

A581
155,00 €

poliert, Gelbgold beschichtet,
Zirkonia white teilausgefasst



B: ca. 9 mm,
klein, mittel, groß

A584
218,50 €

poliert, Roségold beschichtet



B: ca. 2 mm,
klein, mittel, groß

A576
111,00 €

poliert, Roségold beschichtet



B: ca. 4 mm,
klein, mittel, groß

A579
119,00 €

poliert, Roségold beschichtet,
Zirkonia white teilausgefasst



B: ca. 2 mm,
klein, mittel, groß

A582
155,00 €

poliert, Roségold beschichtet,
Zirkonia white teilausgefasst



B: ca. 9 mm,
klein, mittel, groß

A585
218,50 €

matt/polier



B: ca. 4 mm,
Gr. S, M, L

A639
65,00 €

matt/polier



B: ca. 6 mm,
Gr. S, M, L

A643
89,00 €

matt/polier,
Zirkonia white



B: ca. 4 mm,
Gr. S, M, L

A641
89,00 €

matt/polier,
Zirkonia white



B: ca. 6 mm,
Gr. S, M, L

A645
95,00 €

matt/polier,
Gelbgold
beschichtet



B: ca. 4 mm,
Gr. S, M, L

A640
89,00 €

matt/polier,
Gelbgold
beschichtet



B: ca. 6 mm,
Gr. S, M, L

A644
115,00 €

matt/polier,
Gelbgold
beschichtet,
Zirkonia white



B: ca. 4 mm,
Gr. S, M, L

A642
115,00 €

matt/polier,
Gelbgold
beschichtet,
Zirkonia white



B: ca. 6 mm,
Gr. S, M, L

A646
119,00 €

matt/polier/
graviert/gekratzt



Ø ca. 58 mm / groß ca. 62 mm

A306
59,00 €

matt/polier/
graviert/gekratzt



Ø ca. 58 mm / groß ca. 62 mm

A206
59,00 €

matt/polier/
graviert/gekratzt



Ø ca. 58 mm / groß ca. 62 mm

A300
59,00 €

matt/polier/
graviert/geschliffen



Ø ca. 58 mm / groß ca. 62 mm

A209
59,00 €

matt/polier/graviert,
Zirkonia white



Ø ca. 58 mm / groß ca. 62 mm

A407.WH
69,00 €

matt/polier/graviert,
Zirkonia white



Ø ca. 58 mm / groß ca. 62 mm

A410.WH
78,50 €

poliert/graviert/gekratzt



L: variabel bis 21 cm

A554
69,00 €

poliert/graviert,
Zirkonia white



L: variabel bis 21 cm

A557.WH
86,50 €

poliert/graviert,
Zirkonia white



L: variabel bis 21 cm

A560.WH
96,00 €

matt/polier/graviert,
Crystal White Pearl



Ø ca. 58 mm / groß ca. 62 mm

A214.WHP
59,00 €

matt/polier/graviert,
Süßwasserperlen



Ø ca. 58 mm / groß ca. 62 mm

A215
95,00 €

matt/polier/graviert,
Süßwasserperlen



Ø ca. 58 mm / groß ca. 62 mm

A259
95,00 €

matt/polier/graviert,
matte Bergkristall-Perlen



Ø ca. 58 mm / groß ca. 62 mm

A250
70,50 €

matt/polier/graviert,
matte Onyx-Perlen



Ø ca. 58 mm / groß ca. 62 mm

A253
70,50 €

matt/polier/graviert,
matte Rauchquarz-Perlen



Ø ca. 58 mm / groß ca. 62 mm

A256
70,50 €

matt/polier/graviert/gekratzt,
Gelbgold beschichtet



Ø ca. 58 mm / groß ca. 62 mm

A307
70,50 €

matt/polier/graviert/gekratzt,
Gelbgold beschichtet



Ø ca. 58 mm / groß ca. 62 mm

A207
70,50 €

matt/polier/graviert/gekratzt,
Gelbgold beschichtet



Ø ca. 58 mm / groß ca. 62 mm

A301
70,50 €

matt/polier/graviert/geschliffen,
Gelbgold beschichtet



Ø ca. 58 mm / groß ca. 62 mm

A210
70,50 €

matt/polier/graviert,
Gelbgold beschichtet,
Zirkonia white



Ø ca. 58 mm / groß ca. 62 mm

A408.WH
78,50 €

matt/polier/graviert,
Gelbgold beschichtet,
Zirkonia white



Ø ca. 58 mm / groß ca. 62 mm

A411.WH
92,00 €

poliert/graviert/gekratzt,
teilweise Gelbgold
beschichtet



L: variabel bis 21 cm

A555
74,50 €

poliert/graviert,
teilweise Gelbgold
beschichtet, Zirkonia white



L: variabel bis 21 cm

A558.WH
95,00 €

poliert/graviert,
teilweise Gelbgold
beschichtet, Zirkonia white



L: variabel bis 21 cm

A561.WH
104,00 €

matt/polier/graviert,
Gelbgold beschichtet,
Crystal White Pearl



Ø ca. 58 mm / groß ca. 62 mm

A403.WHP
70,50 €

matt/polier/graviert,
Gelbgold beschichtet,
Süßwasserperlen



Ø ca. 58 mm / groß ca. 62 mm

A230
107,00 €

matt/polier/graviert,
Gelbgold beschichtet,
Süßwasserperlen



Ø ca. 58 mm / groß ca. 62 mm

A260
107,00 €

matt/polier/graviert,
Gelbgold beschichtet,
matte Bergkristall-Perlen



Ø ca. 58 mm / groß ca. 62 mm

A251
82,50 €

matt/polier/graviert,
Gelbgold beschichtet,
matte Onyx-Perlen



Ø ca. 58 mm / groß ca. 62 mm

A254
82,50 €

matt/polier/graviert,
Gelbgold beschichtet,
matte Rauchquarz-Perlen



Ø ca. 58 mm / groß ca. 62 mm

A257
82,50 €

matt/polier/graviert/gekratzt,
Roségold beschichtet



Ø ca. 58 mm / groß ca. 62 mm

A308
70,50 €

matt/polier/graviert/gekratzt,
Roségold beschichtet



Ø ca. 58 mm / groß ca. 62 mm

A208
70,50 €

matt/polier/graviert/gekratzt,
Roségold beschichtet



Ø ca. 58 mm / groß ca. 62 mm

A302
70,50 €

matt/polier/graviert/geschliffen,
Roségold beschichtet



Ø ca. 58 mm / groß ca. 62 mm

A211
70,50 €

matt/polier/graviert,
Roségold beschichtet,
Zirkonia white



Ø ca. 58 mm / groß ca. 62 mm

A409.WH
78,50 €

matt/polier/graviert,
Roségold beschichtet,
Zirkonia white



Ø ca. 58 mm / groß ca. 62 mm

A412.WH
92,00 €

poliert/graviert/gekratzt,
teilweise Roségold
beschichtet



L: variabel bis 21 cm

A556
74,50 €

poliert/graviert,
teilweise Roségold
beschichtet, Zirkonia white



L: variabel bis 21 cm

A559.WH
95,00 €

poliert/graviert,
teilweise Roségold
beschichtet, Zirkonia white



L: variabel bis 21 cm

A562.WH
104,00 €

matt/polier/graviert,
Roségold beschichtet,
Crystal White Pearl



Ø ca. 58 mm / groß ca. 62 mm

A404.WHP
70,50 €

matt/poliert/graviert,
Roségold beschichtet,
Süßwasserperlen



Ø ca. 58 mm / groß ca. 62 mm

A231
107,00 €

matt/poliert/graviert,
Roségold beschichtet,
Süßwasserperlen



Ø ca. 58 mm / groß ca. 62 mm

A261
107,00 €

matt/poliert/graviert,
Roségold beschichtet,
matte Bergkristall-Perlen



Ø ca. 58 mm / groß ca. 62 mm

A252
82,50 €

matt/poliert/graviert,
Roségold beschichtet,
matte Onyx-Perlen



Ø ca. 58 mm / groß ca. 62 mm

A255
82,50 €

matt/poliert/graviert,
Roségold beschichtet,
matte Rauchquarz-Perlen



Ø ca. 58 mm / groß ca. 62 mm

A258
82,50 €

*Passende Wechselschließen zu den folgenden Armbändern
finden Sie auf Seite 56:*

Leder braun

**FINE
STEEL
WORKS**



B: ca. 13 mm
L: 18/19/20/21 cm
mit Magnetverschluss flach

A551
63,00 €

Leder khaki

**FINE
STEEL
WORKS**



B: ca. 13 mm
L: 18/19/20/21 cm
mit Magnetverschluss flach

A552
63,00 €

Leder schwarz

**FINE
STEEL
WORKS**



B: ca. 13 mm
L: 18/19/20/21 cm
mit Magnetverschluss flach

A550
63,00 €

Leder anthrazit

**FINE
STEEL
WORKS**



B: ca. 13 mm
L: 18/19/20/21 cm
mit Magnetverschluss flach

A553
63,00 €

SPANGENMASSE

Originalgrößen

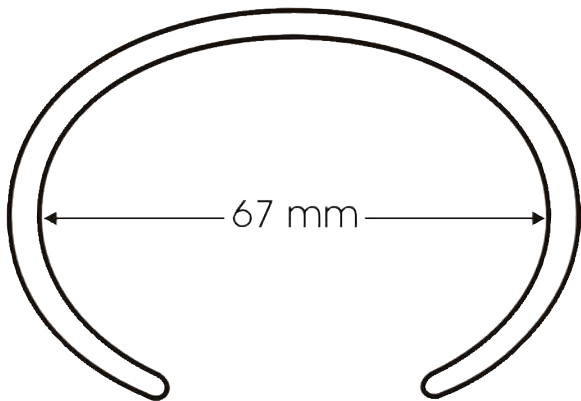
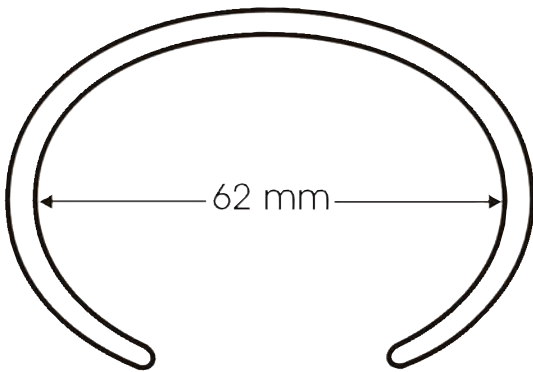
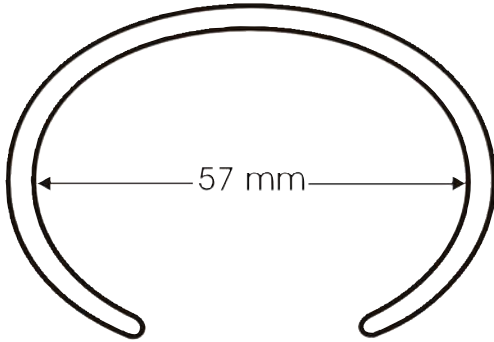

SP1.8 57,50 €

SP2.7 67,50 €



Spiralseil, matt,
 Ø ca. 1,8 mm mit Bajonett-Verschluss Ø 2 mm /
 Ø ca. 2,7 mm mit Bajonett-Verschluss Ø 2,7 mm,
 Preise bis 60 cm Länge

SP1.8C 70,00 €

SP2.7C 77,00 €



Spiralseil, matt,
 Ø ca. 1,5 mm mit Clic-Verschluss Ø 2 mm /
 Ø ca. 2 mm mit Clic-Verschluss Ø 2,5 mm,
 Preise bis 60 cm Länge

SC1.8 41,00 €

SC2.7 46,50 €



Schlangenkette, poliert,
 Ø ca. 1,8 mm mit Bajonett-Verschluss Ø 2 mm /
 Ø ca. 2,7 mm mit Bajonett-Verschluss Ø 2,7 mm,
 Preise bis 60 cm Länge

SC1.8C 53,50 €

SC2.7C 59,00 €



Schlangenkette, poliert,
 Ø ca. 1,8 mm mit Clic-Verschluss Ø 2 mm /
 Ø ca. 2,7 mm mit Clic-Verschluss Ø 3 mm,
 Preise bis 60 cm Länge

SK4.5 126,00 €



Spiralkordel, matt,
 Ø ca. 4,5 mm,
 Preis bis 60 cm Länge,
 mit Bajonett-Verschluss Ø 4,5 mm

DS0.63 38,00 €

DS0.63.GG 44,00 €

DS0.63.RG 44,00 €

Drahtseil, matt,
Gelb- oder Roségold
beschichtet, 1-fach,
Ø 0,63 mm
Preise bis 60 cm Länge,
mit Bajonett-Verschluss Ø 1,8 mm



DS0.63C 49,00 €

DS0.63C.GG 55,00 €

DS0.63C.RG 55,00 €

Drahtseil, matt,
Gelb- oder Roségold
beschichtet, 1-fach,
Ø 0,63 mm,
Preis bis 60 cm Länge,
mit Clic-Verschluss Ø 2 mm

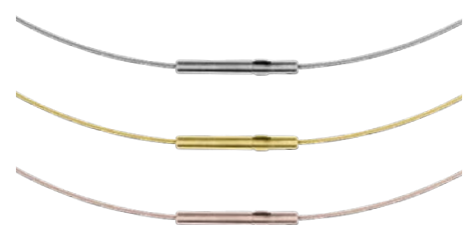

DS1 41,00 €

DS1.GG 45,00 €

DS1.RG 45,00 €

Drahtseil, matt,
Gelb- oder Roségold
beschichtet, 1-fach,
Ø 1 mm
Preise bis 60 cm Länge,
mit Bajonett-Verschluss Ø 1,8 mm



DS1C 53,50 €

DS1C.GG 57,50 €

DS1C.RG 57,50 €

Drahtseil, matt,
Gelb- oder Roségold
beschichtet, 1-fach,
Ø 1 mm,
Preise bis 60 cm Länge,
mit Clic-Verschluss Ø 2 mm



DS2 44,00 €

DS2.bi 46,50 €

DS2.rot 46,50 €

Drahtseil, matt, teilweise
Gelb- oder Roségold
beschichtet, 2-fach,
Preise bis 60 cm Länge,
mit Bajonett-Verschluss Ø 1,8 mm



DS2C 55,00 €

DS2C.Bi 59,00 €

DS2C.rot 59,00 €

Drahtseil, matt, teilweise
Gelb- oder Roségold
beschichtet, 2-fach,
Preise bis 60 cm Länge,
mit Clic-Verschluss Ø 2 mm

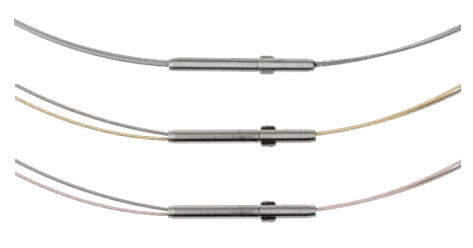

DS2.GG 50,50 €

DS2.RG 50,50 €

Drahtseil, matt,
Gelb- oder Roségold
beschichtet, 2-fach,
Preise bis 60 cm Länge,
mit Bajonett-Verschluss Ø 1,8 mm



DS2C.GG 64,50 €

DS2C.RG 64,50 €

Drahtseil, matt,
Gelb- oder Roségold
beschichtet, 2-fach,
Preise bis 60 cm Länge,
mit Clic-Verschluss Ø 2 mm

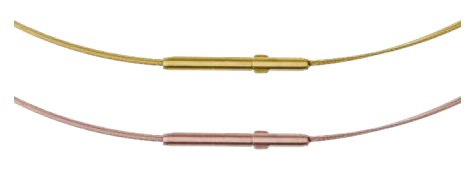

DS5 46,50 €

DS5.bi 55,00 €

DS5.rot 55,00 €

Drahtseil, matt, teilweise
Gelb- oder Roségold
beschichtet, 5-fach,
Preise bis 60 cm Länge,
mit Bajonett-Verschluss Ø 1,8 mm

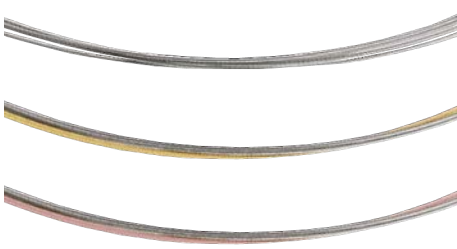

DS5C 59,00 €

DS5C.Bi 67,50 €

DS5C.rot 67,50 €

Drahtseil, matt, teilweise
Gelb- oder Roségold
beschichtet, 5-fach,
Preise bis 60 cm Länge,
mit Clic-Verschluss Ø 2 mm

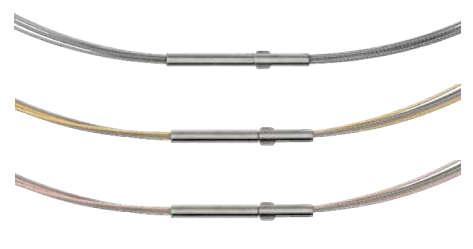

DS5.GG 66,00 €

DS5.RG 66,00 €

Drahtseil, matt,
Gelb- oder Roségold
beschichtet, 5-fach,
Preise bis 60 cm Länge,
mit Bajonett-Verschluss Ø 1,8 mm



DS5C.GG 76,00 €

DS5C.RG 76,00 €

Drahtseil, matt,
Gelb- oder Roségold
beschichtet, 5-fach,
Preise bis 60 cm Länge,
mit Clic-Verschluss Ø 2 mm



DS10 59,00 €

DS10.bi 67,50 €

DS10.rot 67,50 €

Drahtseil, matt, teilweise
Gelb- oder Roségold
beschichtet, 10-fach,
Preise bis 60 cm Länge,
mit Bajonett-Verschluss Ø 2,7 mm

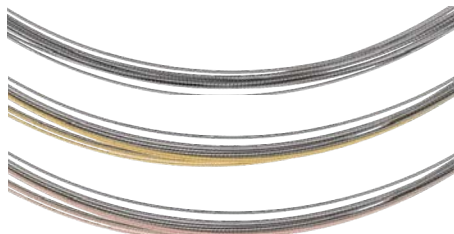

DS10C 70,50 €

DS10C.Bi 77,00 €

DS10C.rot 77,00 €

Drahtseil, matt, teilweise
Gelb- oder Roségold
beschichtet, 10-fach,
Preise bis 60 cm Länge,
mit Clic-Verschluss Ø 2,5 mm



DS10.GG 82,50 €

DS10.RG 82,50 €

Drahtseil, matt,
Gelb- oder Roségold
beschichtet, 10-fach,
Preise bis 60 cm Länge,
mit Bajonett-Verschluss Ø 2,7 mm



DS10C.GG 95,00 €

DS10C.RG 95,00 €

Drahtseil, matt,
Gelb- oder Roségold
beschichtet, 10-fach,
Preise bis 60 cm Länge,
mit Clic-Verschluss Ø 2,5 mm



DS20 101,50 €

DS20.bi 126,00 €

DS20.rot 126,00 €

Drahtseil, matt, teilweise
Gelb- oder Roségold
beschichtet, 20-fach,
Preise bis 60 cm Länge,
mit Bajonett-Verschluss Ø 3,5 mm

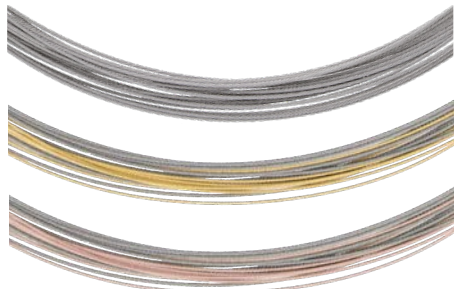

DS20C 113,50 €

DS20C.Bi 134,00 €

DS20C.rot 134,00 €

Drahtseil, matt, teilweise
Gelb- oder Roségold
beschichtet, 20-fach,
Preise bis 60 cm Länge,
mit Clic-Verschluss Ø 3,5 mm



DS20.GG 146,00 €

DS20.RG 146,00 €

Drahtseil, matt,
Gelb- oder Roségold
beschichtet, 20-fach,
Preise bis 60 cm Länge,
mit Bajonett-Verschluss Ø 3,5 mm



DS20C.GG 157,50 €

DS20C.RG 157,50 €

Drahtseil, matt,
Gelb- oder Roségold
beschichtet, 20-fach,
Preise bis 60 cm Länge,
mit Clic-Verschluss Ø 3,5 mm



DS35 157,50 €

DS35.bi 218,50 €

DS35.rot 218,50 €

Drahtseil, matt, teilweise
Gelb- oder Roségold
beschichtet, 35-fach,
Preise bis 60 cm Länge,
mit Bajonett-Verschluss Ø 4,5 mm



DS35.GG 272,00 €

DS35.RG 272,00 €

Drahtseil, matt,
Gelb- oder Roségold
beschichtet, 35-fach,
Preise bis 60 cm Länge,
mit Bajonett-Verschluss Ø 4,5 mm



AK1 41,00 €

AK13 56,00 €

AK14 56,00 €

Ankerkette, poliert,
Gelb- oder Roségold
beschichtet, Ø 2,5 mm,
Preise bis 60 cm Länge,
mit Bajonett-Verschluss Ø 1,8 mm



AK1C 53,50 €

Ankerkette, poliert, 1-fach,
Ø ca. 2,5 mm,
Preis bis 60 cm Länge,
mit Clic-Verschluss Ø 2 mm



AK2 46,50 €

AK15 63,00 €

AK16 63,00 €



Ankerkette, poliert,
Gelb- oder Roségold
beschichtet, Ø 4 mm,
Preise bis 60 cm Länge,
mit Bajonett-Verschluss 3,5 mm

AK2C 59,00 €



Ankerkette, poliert,
Ø ca. 4 mm,
Preis bis 60 cm Länge, mit
Clic-Verschluss Ø 3,5 mm

AK1.3 59,00 €



Ankerkette, poliert, 3-fach,
Ø 3x ca. 2,5 mm,
Preis bis 60 cm Länge,
mit Bajonett-Verschluss Ø 3,5 mm

AK4 53,50 €



Ankerkette,
Ø ca. 7 mm,
Preis bis 60 cm Länge,
mit Bajonett-Verschluss Ø 5,5 mm

AK5 49,00 €

Bajonett-Verschluss
Ø 1,8 mm

AK17 66,00 €

Bajonett-Verschluss
Ø 1,6 mm

AK18 66,00 €

Bajonett-Verschluss
Ø 1,6 mm



Spiegelankerkette, poliert, Gelb- oder Roségold beschichtet, Ø 1 mm,
Preise bis 60 cm Länge

AK5C 63,00 €



Spiegelankerkette, poliert,
Ø ca. 1 mm,
Preis bis 60 cm Länge, mit
Clic-Verschluss Ø 2 mm

AK6 53,50 €

Bajonett-Verschluss
Ø 1,8 mm

AK19 69,00 €

Bajonett-Verschluss
Ø 1,6 mm

AK20 69,00 €

Bajonett-Verschluss
Ø 1,6 mm



Spiegelankerkette, poliert, Gelb- oder Roségold beschichtet, Ø 2 mm,
Preise bis 60 cm Länge

AK6C 66,00



Spiegelankerkette, poliert,
Ø ca. 2 mm,
Preis bis 60 cm Länge, mit
Clic-Verschluss Ø 2 mm

AK7 56,00 €

AK21 70,50 €

AK22 70,50 €

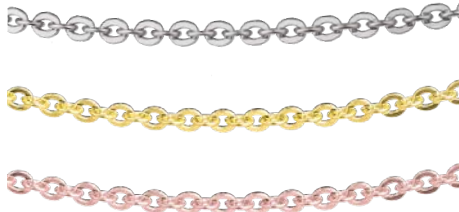

Spiegelankerkette, poliert,
Gelb- oder Roségold
beschichtet, Ø 3 mm,
Preise bis 60 cm Länge,
mit Bajonett-Verschluss Ø 2,7 mm

AK7C 69,00



Spiegelankerkette,
poliert, Ø ca. 3 mm,
Preis bis 60 cm Länge,
mit Clic-Verschluss Ø 2,5 mm

AK8 59,00 €

AK23 73,00 €

AK24 73,00 €



Spiegelankerkette, poliert,
Gelb- oder Roségold
beschichtet, Ø 4 mm,
Preise bis 60 cm Länge,
mit Bajonett-Verschluss Ø 2,7 mm

AK8C 70,50



Spiegelankerkette,
poliert, Ø ca. 4 mm,
Preis bis 60 cm Länge,
mit Clic-Verschluss Ø 3 mm

AK9	59,00 €	
AK11	92,00 €	
AK12	92,00 €	

Zopfketten, poliert, Gelb- oder Roségold beschichtet, Ø 4 mm, Preise bis 60 cm Länge, mit Bajonett-Verschluss Ø 4,5 mm

AK9C	70,50	
------	-------	--

Zopfketten, poliert, Ø ca. 4 mm, Preis bis 60 cm Länge, mit Clic-Verschluss Ø 3,5 mm

AK10	59,00 €	
AK34	78,50 €	
AK35	78,50 €	

Strickketten, poliert, Gelb- oder Roségold beschichtet, Ø 4 mm, Preise bis 60 cm Länge, mit Bajonett-Verschluss Ø 4,5 mm

AK10C	70,50 €	
-------	---------	---

Strickketten, poliert, Ø 4 mm, Preise bis 60 cm Länge, mit Clic-Verschluss 4,5 mm

AK25	35,00 €	
AK26	49,00 €	
AK27	49,00 €	

Kugellketten, poliert, Gelb- oder Roségold beschichtet, Ø 1,5 mm, Preise bis 60 cm Länge, mit Bajonett-Verschluss Ø 1,8 mm

AK25C	46,50	
-------	-------	---

Kugellketten, poliert, Ø ca. 1,5 mm, Preis bis 60 cm Länge, mit Clic-Verschluss Ø 2 mm

AK28	38,00 €	
AK29	53,50 €	
AK30	53,50 €	

Kugellketten, poliert, Gelb- oder Roségold beschichtet, Ø 2 mm, Preise bis 60 cm Länge, mit Bajonett-Verschluss Ø 1,8 mm

AK28C	49,00	
-------	-------	---

Kugellketten, poliert, Ø ca. 2 mm, Preis bis 60 cm Länge, mit Clic-Verschluss Ø 2 mm

AK31	41,00 €	
AK32	59,00 €	
AK33	59,00 €	

Kugellketten, poliert, Gelb- oder Roségold beschichtet, Ø 2,4 mm, Preise bis 60 cm Länge, mit Bajonett-Verschluss Ø 2,7 mm

AK31C	53,50	
-------	-------	---

Kugellketten, poliert, Ø ca. 2,4 mm, Preis bis 60 cm Länge, mit Clic-Verschluss Ø 2 mm

AK36	69,00 €	
AK37	82,50 €	
AK38	82,50 €	

Kugel-Ankerketten, poliert, Gelb- oder Roségold beschichtet, Ø ca. 1 mm, Preise bis 60 cm Länge, mit Bajonett-Verschluss Ø 1,6 mm

AK39	56,00 €	
------	---------	---

Venezianerketten, poliert, Ø 2 mm, Preis bis 60 cm Länge, mit Bajonett-Verschluss Ø 2,7 mm

AK39C 69,00 €



Venezianerkette, poliert,
Ø 2 mm,
Preis bis 60 cm Länge,
mit Clic-Verschluss Ø 2,5 mm

AK42C 64,50 €



Spiegelankerkette, poliert,
Ø ca. 1,5 mm,
Preise bis 60 cm Länge,
mit Clic-Verschluss Ø 2 mm

AK42 50,50 €



AK43 67,50 €



AK44 67,50 €



Spiegelankerkette, poliert,
Gelb- oder Roségold
beschichtet, Ø ca. 1,5 mm,
Preise bis 60 cm Länge,
mit Bajonett-Verschluss 2 mm

AK45C 79,00 €



AK46C 99,00 €



Ankerkette, 3-fach,
Ø 3x 1,5 mm, poliert,
teilweise Gelbgold
beschichtet,
Preise bis 60 cm Länge,
mit Clic-Verschluss Ø 2,5 mm

L2.HB 35,00 €



L2.DB 35,00 €



L2 35,00 €



Lederband, hellbraun,
dunkelbraun, schwarz, Ø 2 mm,
Preise bis 60 cm Länge,
mit Bajonett-Verschluss 2,7 mm

L2.HBC 46,50 €



L2.DBC 46,50 €



L2C 46,50 €



Lederband, hellbraun,
dunkelbraun, schwarz,
Ø 2 mm,
Preise bis 60 cm Länge,
mit Clic-Verschluss Ø 2,5 mm

LG4.HB 53,50 €



LG4.DB 53,50 €



LG4.SW 53,50 €



Lederband, hellbraun,
dunkelbraun, schwarz,
Ø 4 mm,
Preise bis 60 cm Länge,
mit Bajonett-Verschluss Ø 4,5 mm

LG4C.HB 66,00 €



LG4C.DB 66,00 €



LG4C.SW 66,00 €



Lederband, hellbraun,
dunkelbraun, schwarz,
Ø 4 mm,
Preise bis 60 cm Länge,
mit Clic-Verschluss Ø 4,5 mm

KS2 35,00 €



KS3 39,50 €



KS4 44,00 €

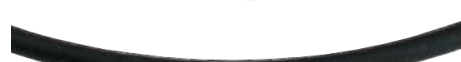

Kautschukseil, schwarz,
Ø 2/3/4 mm,
Preise bis 60 cm Länge,
mit Bajonett-Verschluss Ø 2,7/3,5/4,5 mm

KS2C 46,50 €



KS3C 50,50 €



KS4C 55,00 €



Kautschukseil, schwarz,
Ø 2/3/4 mm,
Preise bis 60 cm Länge,
mit Clic-Verschluss Ø 2,5/3,5/4,5 mm

KS3fach 46,50 €



Kautschukseil, schwarz,
3-fach, Ø 3x 2 mm
Preise bis 60 cm Länge,
mit Bajonett-Verschluss 4,5 mm

ENTWURF UND HERSTELLUNG

Andreas Ernst

Ernstes Design · Max-Born-Str. 12 · 48529 Nordhorn

PRODUKTEIGENSCHAFTEN:

- chirurgischer Edelstahl
- kein Anlaufen, kein Oxidieren des Edelstahls
- lange Lebensdauer
- pflegeleicht

ANGABEN ÜBER APPLIKATIONEN:

- 585er Gelbgold oder Roségold
- hochwertige Beschichtungen
- Platin 960, Platin 600
- Qualität der Brillanten TW/SI
- Carré-Diamanten in der Qualität TW/SI mit dem Schliff „princess cut“.
- Süßwasserzuchtperlen

ANGABEN ZU DEN KETTEN UND SEILEN:

- geliefert wird eine Standardlänge von 42 cm, wenn nicht anders bestellt
- Preise gelten bis zur angegebenen Länge
- Sonder- und Zwischenlängen möglich, Preise auf Anfrage, Umtausch/Rücknahme ausgeschlossen
- die Collier-Sets K600.S bis K681.S beinhalten einen silk wood Außenrahmen, einen Anhänger und ein Lederband in den abgebildeten Farben

ANGABEN ZU DEN RINGEN:

- erhältliche Ringgrößen siehe Artikelbeschreibungen
- Farbabweichungen vorbehalten
- Kein silk wood Schmuckstück gleicht dem anderen. Die Struktur des Materials ist immer ein wenig anders - Farb- und Musterabweichungen sind daher normal und müssen akzeptiert werden.
- Sonderanfertigungen möglich, Preise auf Anfrage, Umtausch/Rücknahme ausgeschlossen

ANGABEN ZU DEN ARMSPANGEN und ARMBÄNDERN:

- Armspangen sind in den Größen klein, mittel und groß erhältlich, siehe Originalgröße auf Seite 93
- Standardlängen der Armbänder: 19 cm, 20 cm, 21 cm (wenn nicht anders angegeben); Preise gelten bis 25 cm Länge
- Sonder- und Zwischenlängen möglich, Preise auf Anfrage, Umtausch/Rücknahme ausgeschlossen
- abweichend hiervon sind die Armbänder A550-A553 ausschließlich in den Längen 18 cm, 19 cm, 20 cm und 21 cm erhältlich!

ANGABEN ZU DEN ANHÄNGERN:

- Anhänger werden ohne Seile und Ketten geliefert
- Sonderanfertigungen möglich, Preise auf Anfrage, Umtausch/Rücknahme ausgeschlossen

ANGABEN ZU SCHMUCKSTÜCKEN MIT MAGNET:

- Bitte beachten Sie, dass Magnetfelder Datenträger wie Festplatten, Disketten, Scheckkarten mit Magnetstreifen, Audio- und Videokassetten usw. löschen, elektronische und mechanische Komponenten wie Herzschrittmacher, Uhren, Zähler, Kompass, Monitore, usw. beeinflussen bzw. zerstören können.

GRAVUREN:

- Wir bieten Ihnen durch moderne Techniken eine Vielzahl von Gravur-Möglichkeiten an. Bei Ringen ist die Innenfläche ab einer Profildicke von 3,5 mm gravierbar. Es können aber auch andere Schmuckstücke individuell graviert werden. Weitere Informationen finden Sie in unseren Gravur-Merkblättern. Sprechen Sie uns gerne an!

ALLGEMEINE HINWEISE:

- Vermeiden Sie den Kontakt der Schmuckstücke mit Chemikalien wie z.B. Reinigungsmitteln, oder flüssigen Kosmetikartikeln wie Parfums etc.
- Benutzen Sie zur Reinigung ein weiches Tuch, warmes Wasser und etwas Spülmittel.
- Auf Reisen transportieren Sie Ihre Schmuckstücke bitte getrennt voneinander.
- Perlen, Steine, Edelsteine, Halbedelsteine und Leder sind Naturprodukte, die in Farbe und Beschaffenheit variieren können.
- Die Schmuckstücke sowie deren Beschichtungen können durch das Tragen Kratzer/Abnutzungen aufweisen. Wie schnell das geht, hängt von der Beanspruchung des Schmuckstücks ab. Dies sind normale Tragespuren und daher kein Reklamationsgrund.

PREISSTELLUNG:

- Angaben UVP (unverbindliche Preisempfehlung) in Euro inklusive MwSt.
- Änderungen sowie Irrtümer behalten wir uns vor.

Stand: Oktober 2024

ED **vita**

ED **vita** petit

evia

**FINE
STEEL
WORKS**

ERNSTES  DESIGN
JEWELRY MADE IN GERMANY